

Representative



Technology Education Concepts
www.TECedu.com | 800-338-2238
info@TECedu.com

TRAINING SYSTEMS FOR DRIVE TECHNOLOGY

Acquiring practical and project-based
skills and expertise



CONTENTS

LabSoft – Digital learning. Hardware controlling.

Complex content presented in a clever way 4

Different systems for different needs

UniTrain – Multimedia laboratory with 100 courses 6

Training panel system 8

Assembly and installation exercise system 9

Computer-based learning platform

Interactive Lab Assistant (ILA) –

The LabSoft Classroom Manager

fits all training systems 10

The entire program at a glance 12

More than a laboratory

Comprehensive solutions for modern drives 14

One drive program – Two power classes 16

Full-coverage and extensive –

the servo machine test bench 18

Easy to operate and take measurements on the PC 20

Analog-digital multimeter 22

Electrical machines

DC machines 26

Asynchronous (induction) machines 27

Synchronous and slip-ring machines 28

Stepper motors 29

BLDC/servo motor 30

Linear motor 31

Three-phase transformer 32

Electromagnetic compatibility 33

Manufacturing single- and three-phase transformers 34

Manufacturing a three-phase motor with

squirrel-cage rotor 35

DC machines 36

Universal motor 37

Single-phase motor with bifilar starter winding 38

Single-phase motor with operating and starting capacitor .. 39

Energy-saving motors 40

Squirrel cage motor 41

Dahlander motor 42

Three-phase motor with two separate windings 43

Three-phase motor with slip-rings 44

Trouble-shooting on electrical machines 45

Protection of electrical machines 46

Manual switching in the three-phase circuit 47

Contactor circuitry in the three-phase circuit 48

Synchronous machines 49

Grid synchronisation 50

Three-phase reluctance machine 51

One stator, various rotors 52

Single-phase and three-phase transformers 53

Power electronics and didactically designed drives

Line-commutated converter 56

Self-commutated converter 57

Frequency converter drives 58

Active power factor correction PFC 59

Line-commutated converter circuits 60

Converter drives with DC motors 61

Self-commutated converter circuits 62

Frequency converter drives 63

Servo drives, electronically commutated motor 64

Inverter-fed drives with DC motor 65

Model-based design of drives using Matlab®/Simulink®

Expanding the training system into a programmable rapid-prototyping system

for drive technology 68

Field-oriented control of asynchronous (induction) motors

with Matlab®/Simulink® 70

Automatically controlled permanent-magnet servo drives

with Matlab®/Simulink® 72

DC drives with cascade control using Matlab®/Simulink® ... 74

Industrial drives

Smooth starting three-phase machines 78

Drives with frequency converters 79

Project-based work using frequency converters 80

Positioning with linear axes 81

Positioning with synchronous servo drives 82

Motor protection/motor management 83

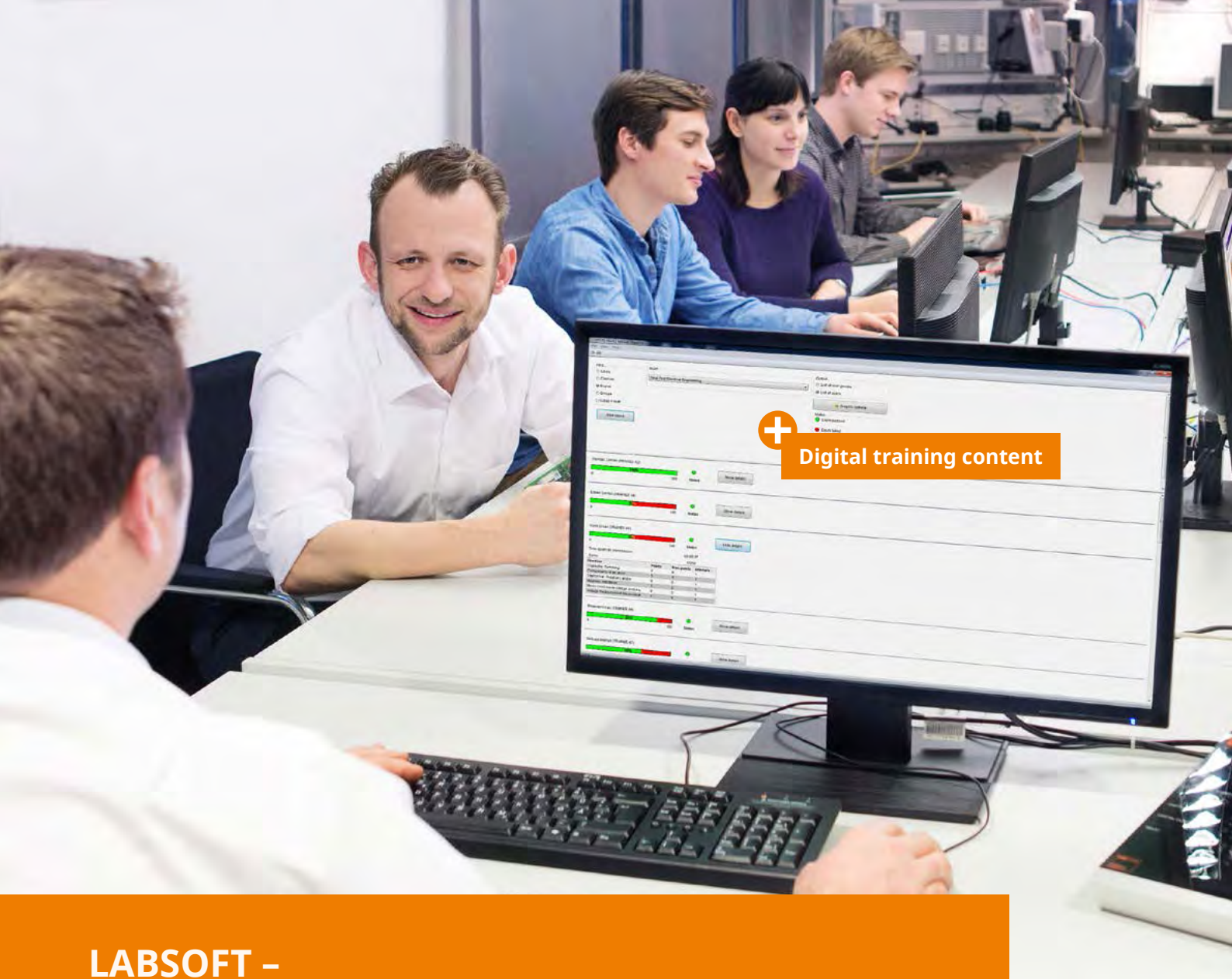

LABSOFT – DIGITAL LEARNING. HARDWARE CONTROLLING.

Smart presentation of complex content

LabSoft provides users with a simple navigation concept to access all the content. The intelligent software also controls the UniTrain Interface and all the Lucas-Nülle hardware. LabSoft also stores all the measurements made by each user separately, making it the ideal tool for monitoring learning progress.

Benefits

- Direct access to all course content
- Control of Lucas-Nülle hardware via virtual instruments
- User-specific storage of measurement results
- The system can operate locally, on a network or in combination with learning management systems
- Available in a wide variety of languages: All languages supported by HTML

ANALOG IN

CURRENT

E+ E-
F+ F-

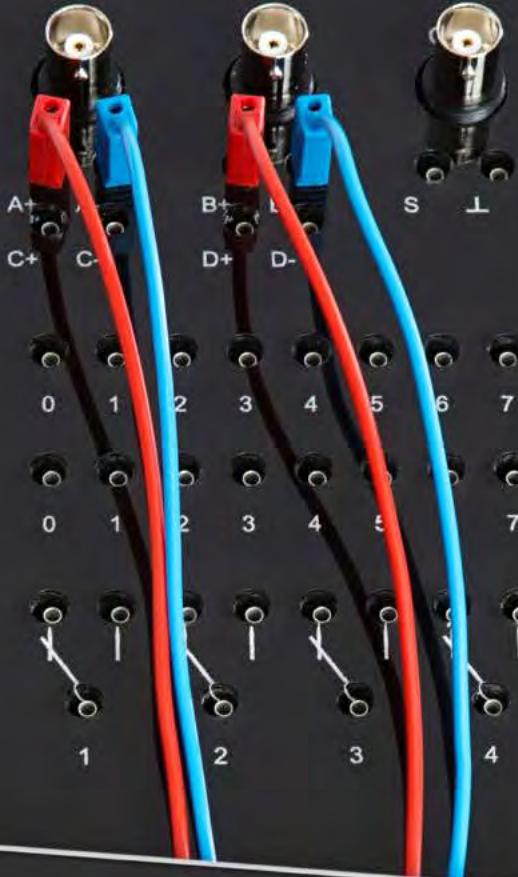

DIGITAL IN

DIGITAL OUT

RELAY



Virtual instruments allow you to control the training systems via LabSoft.

IN 3-PHASE POWER SUPP... - x

AC VOLTAGE [V] FREQUENCY [Hz]

10.8 8.50

POWER

POWER SUPPLY

20 V

VOLTMETE... - x

10.0 V

DC AC

AV [AV] PP RMS

A/D

Öffnen S
Frequer

Instrumente M
eine Strangspa

Messen Sie die Wicklungsspannung

Lesen Sie die Messwerte von W

Multimeter A: Strangspannung $U_{str U} = 10$ V

Multimeter B: Strangsstrom $I_{str U} = 0,28$ A

klungsstrom I_{str}

ssstrom ab und üb

5

Berechnen Sie aus den Messwerten die aufgenommen

S = 2 * U

04-7T
ung zur P
10

ung
ckschaltung
Messungen am Dr
Drehstromgenerator
Asynchronmaschinen
Synchronmaschinen
Kondensatormotor
Drehtransformator
Temperaturmessung m
Fehlersuche Drehstror
Wissenstest Asynchron

Copyright

LUCAS-NÜLLE LabSoft

UniTrain

DIFFERENT SYSTEMS FOR DIFFERENT NEEDS



UNITRAIN SYSTEM

UniTrain - Multimedia laboratory with 100 courses

Using the multimedia-based UniTrain experiment and training system, the student is guided through the theory and experiment exercises in clearly structured course software accompanied by helpful explanatory texts, graphics, animations, and tests. In addition to the training software, there is an experiment card on which practical exercises are conducted included with every course. Courses on the subjects of „Electrical machines“, „Power electronics“ and „Drives“ teach the required know-how and skills needed for an understanding of modern drives including connection, control and operation. Supported by an array of animations and experiments on real systems, the various courses explore and elaborate on the fundamentals, principles and attributes of components used in electrical motors, power electronics and drive systems.

Benefits

- Theory and practice in the same place at the same time
- Motivation is boosted by the PC and new media
- Rapid success thanks to well-structured course guidance
- Rapid understanding of theory thanks to animations
- Acquire practical skills through autonomous experimenting
- Continuous feedback thanks to comprehension queries and knowledge tests
- Guided troubleshooting with built-in fault simulation
- Safety ensured by the use of safety extra-low voltage
- Huge selection of courses
- Sample solutions



UniTrain system

- Complete, portable laboratory
- Multimedia courses
- High-tech measurement and control interface
- Theory and practice at the same time



UniTrain Interface with USB

- Oscilloscope with 2 analog differential inputs
- Sampling rate 40 MSamples
- 9 measurement ranges 100 mV - 50 V
- 22 time ranges 1 μ s - 10 s
- 16 digital inputs and outputs
- Function generator up to 1 MHz
- 8 relays for fault simulation



UniTrain experimenter

- Accommodates the experiment cards
- Experiment voltage ± 15 V, 400 mA
- Experiment voltage 5 V, 1 A
- Variable DC or three-phase source 0 ... 20 V, 1 A
- IrDa interface for the multimeter
- Additional serial interfaces for the cards



Built-in instruments and power supplies

- Multimeter, ammeter, voltmeter
- 2-channel storage oscilloscope
- Function and waveform generator
- Three-fold power supply for AC and DC
- Three-phase power supply unit
- ... and many other devices

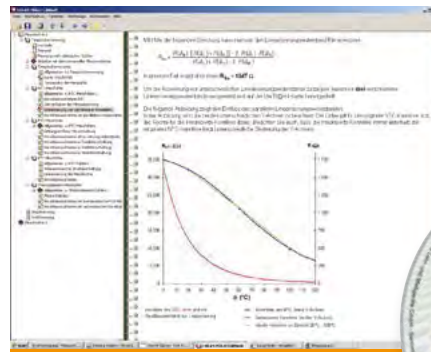

Training and experiment software LabSoft

- Huge selection of courses available
- Extensive theory
- Animations
- Interactive experiments with instructions
- Navigate at will
- Document the measurement results
- Knowledge tests



TRAINING PANEL SYSTEM

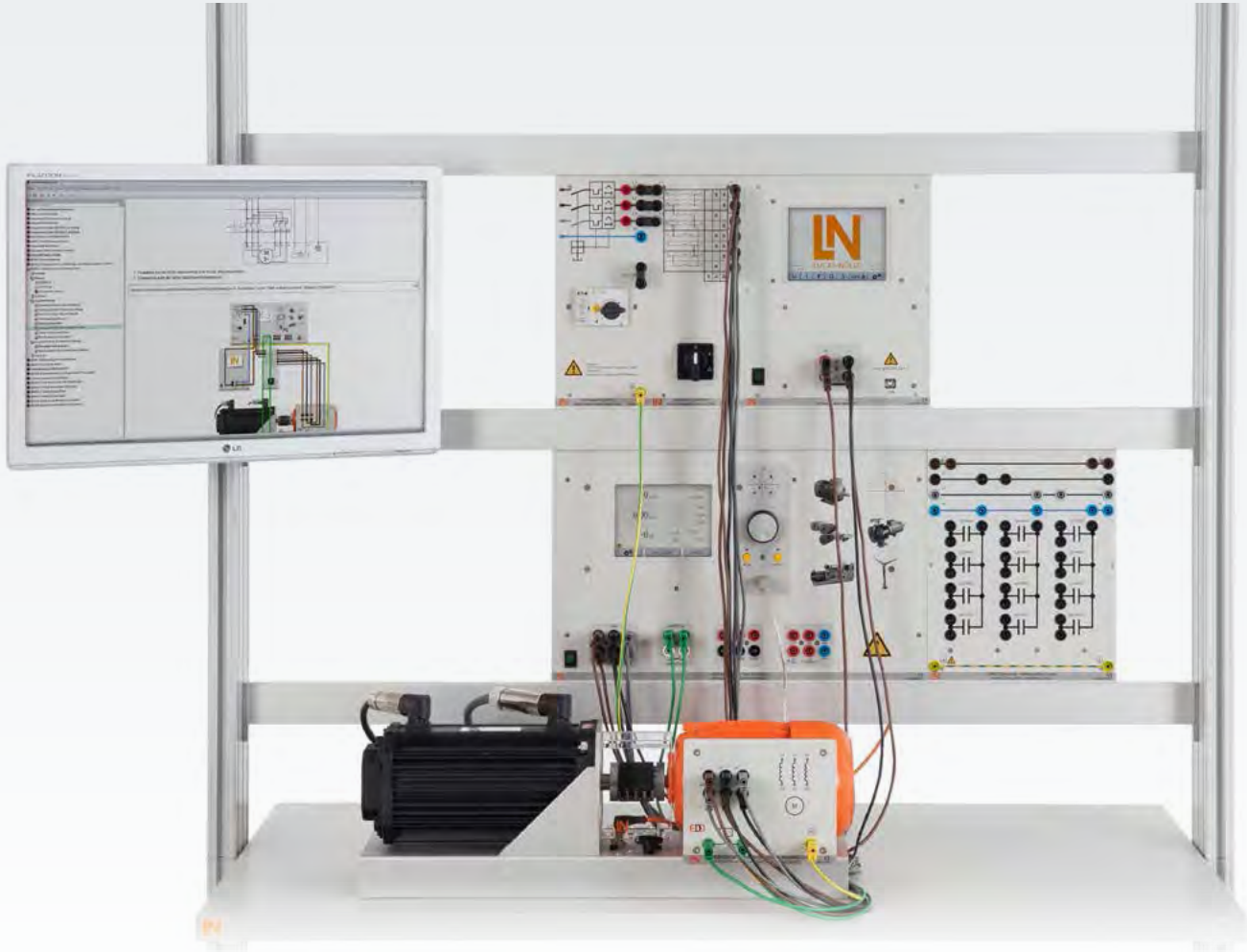

Whether it is for traditional frontal instruction or practice-oriented student experiments with training panel systems you can implement any teaching and learning methods you prefer. The training panels consist of panels of laminated sheets, which are coated on both sides with melamine resin.

Each panel has a uniform height of DIN A4. This permits the panels to be easily suspended in experiment stands.

Benefits

- Versatile and flexible thanks to their modular design
- Well suited for student exercises and demonstration
- Safe thanks to its double insulation
- (safety sockets and safety cables)
- Industry relevant due to the integration of industrial equipment
- Clear orientation thanks to contrast-rich and scratch-free front panel print graphics
- Modern instrumentation with PC link
- Interactive Lab Assistant (ILA) helps to facilitate the conducting of experiments
- Student worksheets and sample solutions

ASSEMBLY AND INSTALLATION EXERCISE SYSTEM



The perfect complement for project-oriented work

When you do installation and assembly exercises it is all about technical, hands-on skills. All exercises have a very strong focus on practice. The electrical connections are performed using industrial wiring materials like mounting rails, racks as well as screws and various wiring methods. All of the parts except for the consumable materials (cables) can be reused again and again.

Benefits

- Plan and implement projects
- Learn connecting techniques
- High-degree of practical application thanks to technical documentation and software typically found in industry
- Combinable with the training panel system
- Circuitry implemented using industrial components
- Comprehensive project documentation

COMPUTER-BASED LEARNING PLATFORM

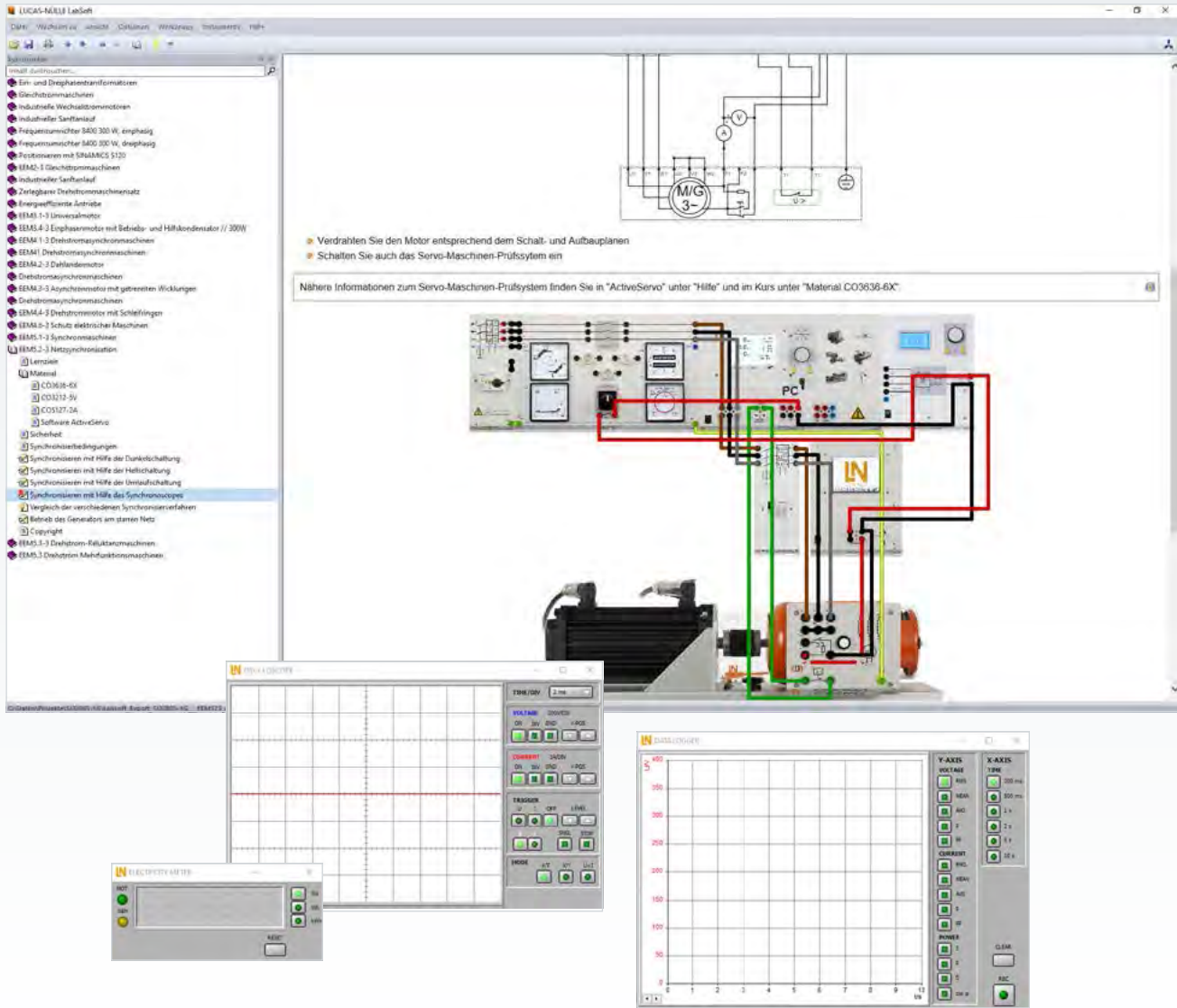

Interactive Lab Assistant (ILA)

When performing the experiments, you are supported by an Interactive Lab Assistant (ILA). It not only guides you through the experiment but also provides valuable theoretical information, records measurement values and all the while in the background automatically creates the required laboratory documentation as a print or PDF document. If you wish to fine-tune the guiding instructions, simply use the Labsoft Classroom Manager to change or supplement the content.

Benefits

- Teaching theory using easy-to-understand animations
- Support while performing the experiments
- Interactive demonstration of experiment set-ups
- Access to real measuring and testing equipment with comprehensive evaluation possibilities
- Practice-oriented project assignments
- Integrated operating instructions
- Documentation of the experiment results
- (compilation of an experiment report)
- Knowledge questions incl. feedback function

The LabSoft Classroom Manager

is an administration software with extensive functionality. It permits practice-based teaching and learning processes to be organized and managed comfortably. The Classroom Manager is well suited for all LabSoft-based learning programs like ILA, UniTrain, InsTrain and CarTrain.

It consists of the following program elements:

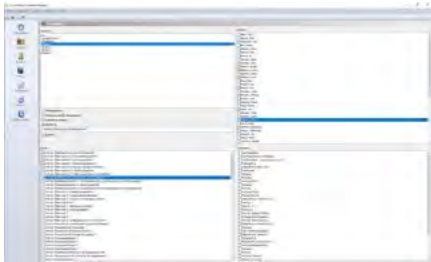

LabSoft Manager

Manage your LabSoft courses, students and learning groups using the LabSoft Manager. That way, the right learning material is always available for your students.



LabSoft Questioner

Many question types are available in the LabSoft Questioner for the creation of queries, measurement exercises and test questions. These exercises and questions can be inserted into the courses and exams.



LabSoft Editor

Numerous aids in the LabSoft Editor help you to create new courses and assist users by guiding them step-by-step through the necessary instructions.

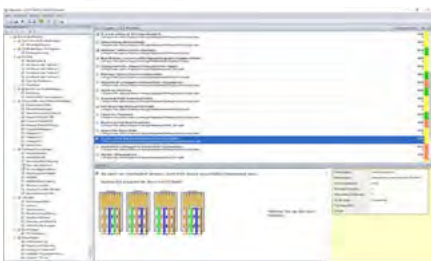

LabSoft TestCreator

Tests are created which can be used to simultaneously assess both knowledge and skill level. Filter functions help you in selecting test questions both manually and automatically.

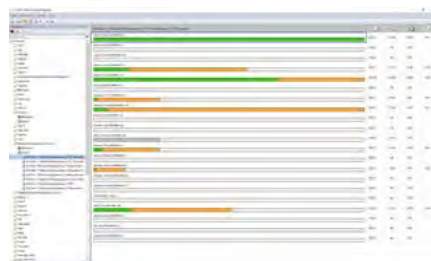

LabSoft Reporter

Learning progress and test results are presented by the LabSoft Reporter. Numerous evaluations for individual and group results of courses and exams facilitate systematic monitoring and supervision.



LabSoft ControlCenter

With the ControlCenter you are always up-to-date on everything in your classroom. It shows what your class is currently working on, inserts help questions and permits the distribution of individual screen content to the group.

THE ENTIRE PROGRAM AT A GLANCE

INDUSTRIAL DRIVES

- Putting into operation
- Setting and optimising parameters
- Operating with industrial loads
- Networking with PLC controls
- Project work

EDT 17
Smooth starting three-phase machines

DIDACTICALLY DESIGNED DRIVES

- Operation
- Optimisation
- Operating response

EPE 31
Converter drives with DC motors

EPE 41
Frequency converter drives

EPE 42
Servo drives

EPE 43
Converter drives with DC motor

POWER ELECTRONICS

- Circuitry
- Power semiconductors
- Identifying operational and technical context

EPE 30
Line-commutated converter circuits

EPE 40
Self-commutated converter circuits

POWER ELECTRONICS

- Connection
- Starting
- Motor response
- Measuring speed and torque
- Characteristics
- Project work

EEM 4.5
Fault simulation on electrical machines

EEM 4.6
Protection for electrical machines

EST 1
Manual switching in three-phase circuits

EST 2
Contractor circuits in three-phase circuits

EEM 2
DC machines

EEM 3
AC machines

UNITRAIN

- Basic training
- Fundamentals
- Understanding function and operation

Course
DC machines

Course
Asynchronous machines

Course
Synchronous and slip-ring machines

Course
Stepping motor

Course
BLDC / servo motor

EDT 25 Frequency converter drives	ELP 25 Project work: industrial wiring of frequency-converter drives	EDT 32 Positioning with synchronous servo drives	EDT 33 Positioning with linear axis	EDT 51 Motor management relays
---	--	--	---	--

DESIGNING DRIVE CONTROLLERS WITH MATLAB®/SIMULINK®

- Rapid implementation of user-defined and reconfigurable processor/hardware-in-the-loop systems using automatic generation of code
- Algorithm engineering to bridge the gap between theory and practice

EPE 51 Field-oriented control with Matlab®/Simulink®	EPE 52 Variable-speed servo drives with Matlab®/Simulink®	EPE 53 Variable-speed DC drives with Matlab®/Simulink®
--	---	--

EEM 5.2 Mains synchronisation	EEM 5.3 Three-phase reluctance machine
---	--

EEM 5.1 Synchronous machines	EEM 10 Dismountable three-phase machine set	ENT 5 Transformer trainer	EMW 10 Winding transformer coils	EMW 20 Winding electrical machine coils
--	---	-------------------------------------	--	---

Course Linear motor	Course Single & Three-phase transformers	Course Electromagnetic compatibility (EMC)	Course Line-commutated power converters	Course Self-commutated power converters	Course Frequency converter drives	Course Active power factor correction PFC
-------------------------------	--	--	---	---	---	---

MORE THAN A LABORATORY

Complex training content
presented vibrantly using modern learning media

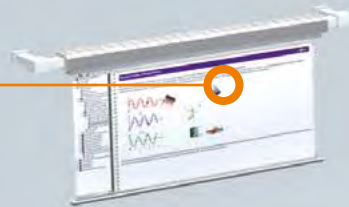

Comprehensive solutions for modern drives
Frequency converters, servo drives, positioning,
soft starters, motor management relays

Connection, starting and testing
of DC, AC, three-phase and synchronous machines



Blended Learning
Multimedia-based teaching of know-how
with UniTrain

ONE DRIVE PROGRAM – TWO POWER CLASSES



300 W and 1 kW classes available



For the training of experts in electronics and mechatronics, the complex area of drive technology is particularly challenging. The understanding and mastery of electrical machines, their design, operation, connection techniques, characteristics and especially their response to different loads constitute core expertise in this area for specialists, technicians and engineers. To meet the various needs in this area, Lucas-Nülle provides drives in two different power classes – 300 W and 1 kW.

300 W and 1 kW – two power classes, two user groups

- Recording typical machine characteristics
- Specially designed machines feature operating responses corresponding to machines having significantly higher power
- 300 W – standard equipment for drive technology and mechatronics



Safe operation

All connections carried out with safe connecting leads and sockets.

- High degree of circuit safety
- Clear labelling of all connection terminals
- Designations in accordance with DIN/IEC standards
- Secure protection of all rotating parts using guards
- Machinery protected against thermal overload thanks to temperature sensors
- 1 kW – premium equipment set for drive technology, mechatronics and power engineering

Optimum handling features

All machines of one power class are equipped with the same shaft height and a vibration-damping base frame.

- Permits simple, stable coupling of machines and attachable parts
- Snug, elastic coupling sleeves
- Friction-locking and disturbance-free operation

COMPLETE AND EXTENSIVE – THE SERVO MACHINE TEST STAND



300 W and 1 kW classes available



The servo machine test stand is a complete testing system for the investigation of electrical machines and drives. It is comprised of the digital control unit, a servo drive and the ActiveServo software. The system combines the latest technology with simple operation. In addition to drive and brake operations, the system can also emulate the driven machine models realistically. That way machines, generators and drives can be investigated in the laboratory under typical industrial conditions. The system contains ten different operating modes/ driven machine models. A specially adapted system exists for both power classes.

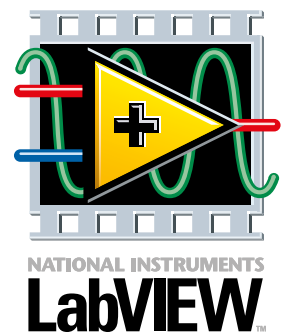



Control unit

- Drives and brakes operate in four quadrants
- Dynamic and steady-state operation
- Electrically isolated USB port for more protection against interference
- Able to determine speed and torque
- Integrated measurement amplifier for measuring current and voltage
- 5.7" touch display for easy operation
- Low-noise operation thanks to innovative cooling



Drive unit

- Self-cooling servo-motor
- Integrated speed and rotor position detection via resolver
- Temperature monitoring thanks to built-in temperature sensor
- Drift- and calibration-free system
- Speed-connect plug-in system for quicker set-up times
- High power reserve for true-to-life emulation of loads



Comprehensive safety concept

- Detection mechanism for all shaft guards
- Upgraded protection against contact thanks to flush-fitting covers
- Built-in illumination signals that safety function is intact
- Supply voltage of connected machinery is disconnected when the shaft guard is removed
- Temperature monitoring of device under test



Electronic rating plate EDD

- Motors are equipped with an electronic rating plate (Electronic Drive Data)
- Relevant machine data is automatically uploaded
- Presetting of scaling in the ActiveServo software

SIMPLE OPERATION AND MEASUREMENT RECORDING ON PC

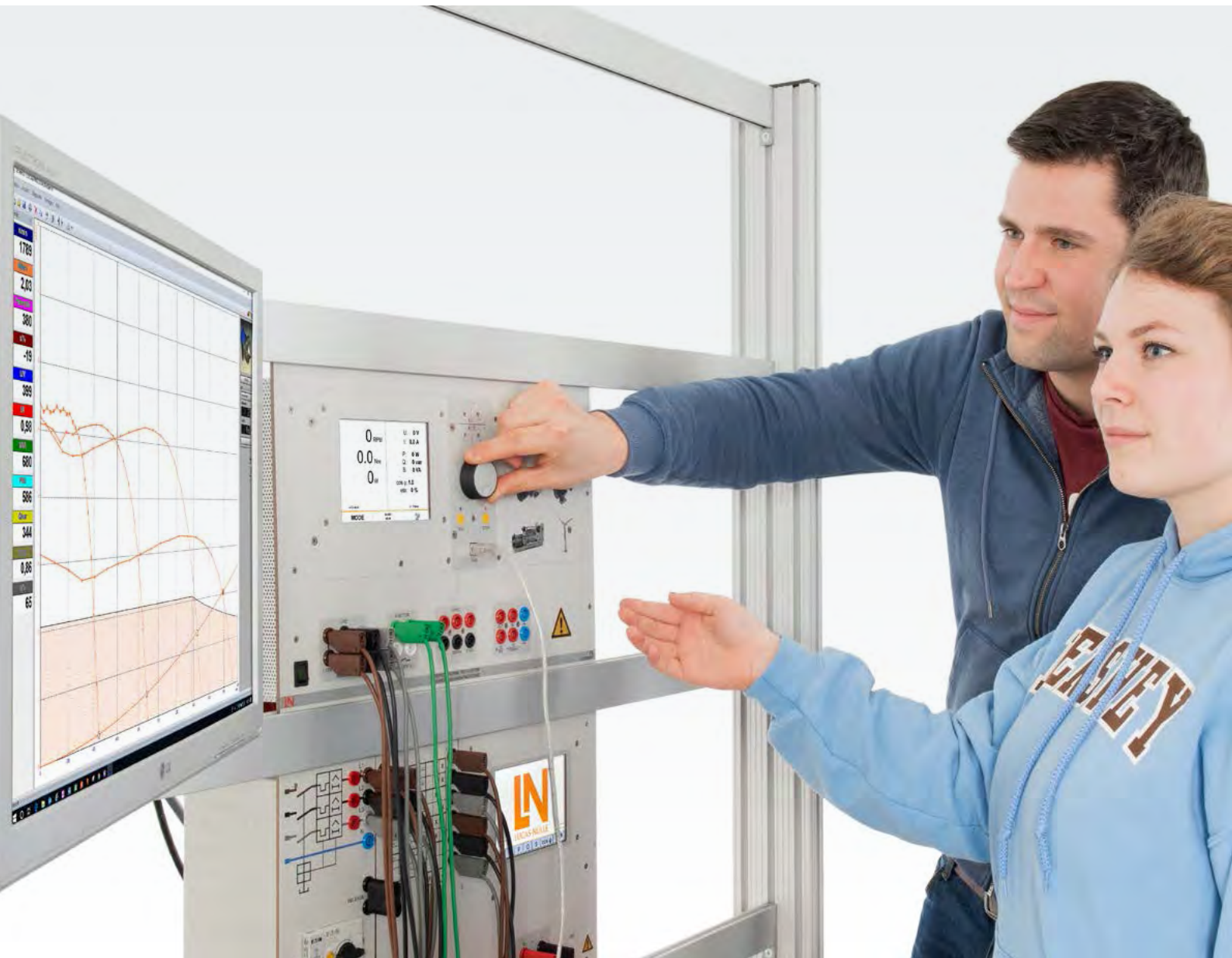

Various programs specialized for specific needs permit the servo machine test system to be operated via the PC.

ActiveServo 2.0

- Permits the recording of motor characteristics
- Determines the operating points for a variety of driven machines
- Plots dynamic processes such as starting or braking a motor drive

PosiDrive

- Set positioning drive parameters
- Definition of setpoint positions with freely selectable values for ramp times, maximum speed and maximum torque
- Graphic plotting of position, torque, speed and drag errors

Integration into LN-SCADA for Power Lab

- Control operation takeover by the SCADA software
- Designing, setting parameters and operating generator controls
- Emulation of wind power plants
- Complex performance characteristics can be programmed with the software-based PLC

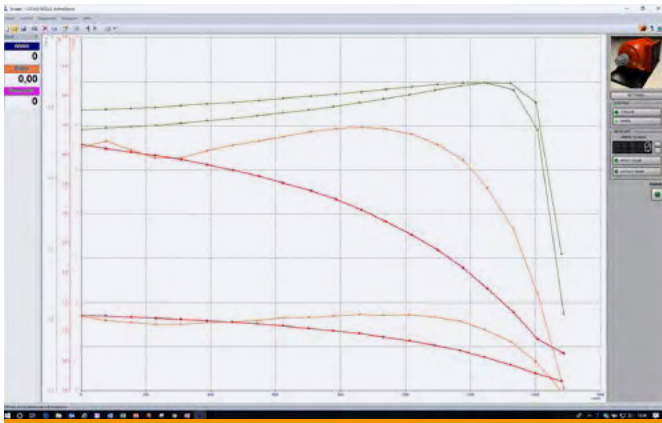

Recording motor characteristics

- Measurement over all four quadrants
- Recording measurement values in variable speed and torque operating mode
- Measurement, calculation and display of both measured and calculated mechanical and electrical variables
- Ramp functions can be defined as desired for carrying out PC-controlled load experiments

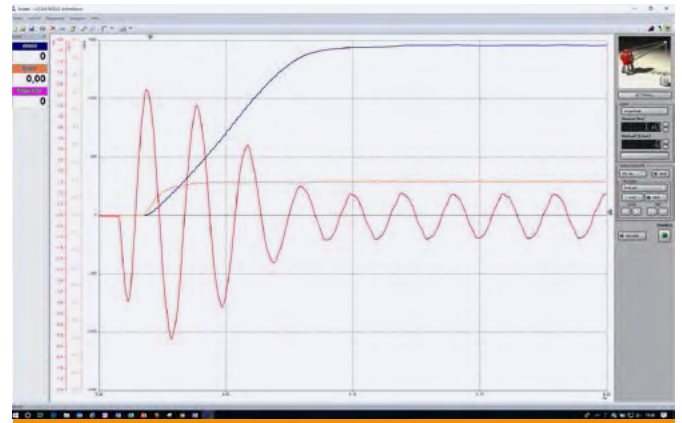

Recording dynamic processes

- Determining start-up currents for various loads
- Investigating the dynamic response of variable-speed drives
- Realistic emulation of driven machines also during dynamic operating processes
- Plotting of electrical variables as instantaneous value or as rms value

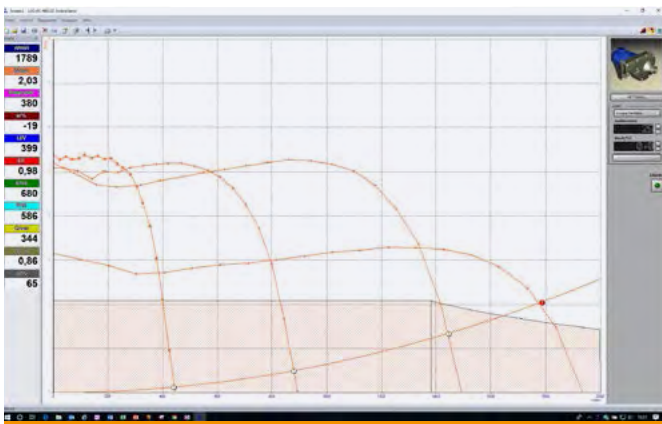

Determining operating points

- Superpositioning of curves from driving and driven machines
- Realistic, detailed emulation of pumps, ventilators, lifting equipment, calendars, flywheels, piston compressors, winding drives as well as a freely definable driven machine
- Determining operating points
- Determining operating and overload range

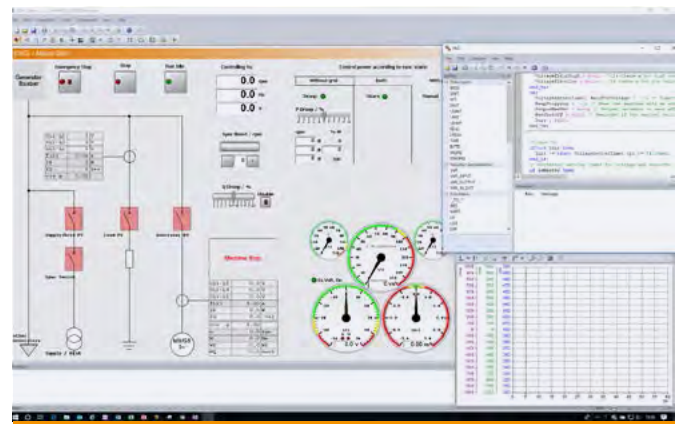

Integration into LN-SCADA for Power Lab

- Easy integration into the SCADA software
- Control and display of measurement values in real time
- Plotting of measurement values over time
- Control using integrated software-based PLC
- Addressable as OPC client or as SCADA remote client

ANALOG-DIGITAL MULTIMETER – FOUR DIFFERENT MEASURING INSTRUMENTS COMBINED IN ONE DEVICE



The areas of electrical machines, power electronics and drive technology place particular demands on measuring instruments. In addition to high overload protection, the detection of the measurement values must be carried out regardless of waveform. The analog-digital multimeter is designed especially for these needs. It simultaneously replaces up to four different measuring devices by being a current/voltage, power and phase-angle meter in one. The graphic display permits the device to be used as a student device and for experiment demonstrations.

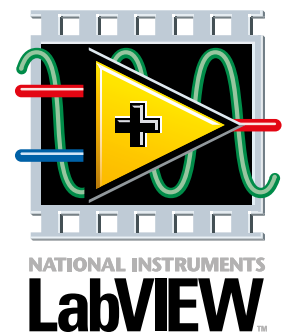

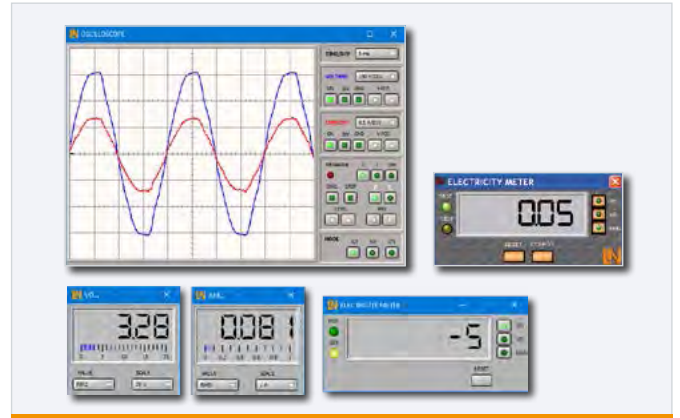

Equipment set

- Simultaneous measurement of voltage and current regardless of waveform (measuring clocked voltages)
- Calculation of active, apparent and reactive power and power factor
- Electrically protected up to 20 A/600 V
- Large, contrast-rich graphic display with background illumination
- Large display or indication of up to 4 measurement values

PC link

All measured values can be displayed on the PC via USB port. The following instruments are available:

- Voltage, current, power display instrument
- Power meter for motor and generator operation
- Oscilloscope to display current, voltage and power
- Data logger to record up to 14 different measurement variables

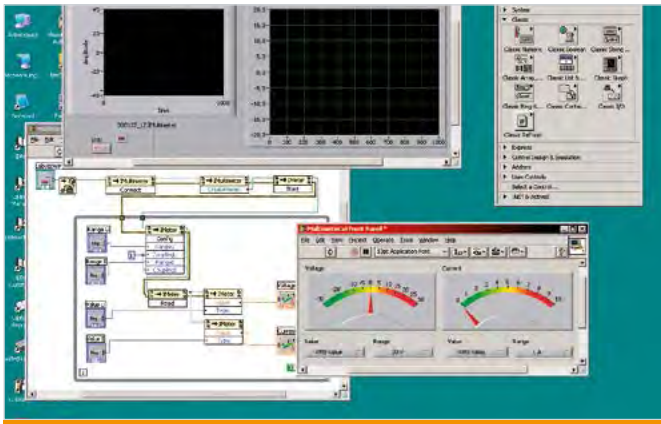

LabVIEW compatible

LabVIEW driver, as well as different function examples, permit the integration of the analog-digital multimeter into the LabVIEW environment.

ELECTRICAL MACHINES

The image shows a complex industrial system, likely a power plant or refinery, featuring large blue-painted metal components and silver-colored pipes. Two prominent vertical cylindrical units are visible, each with a pressure gauge attached to its side. The background is filled with a dense network of pipes and structural elements, creating a sense of a large-scale industrial environment. The lighting is bright, highlighting the metallic textures and the blue paint.

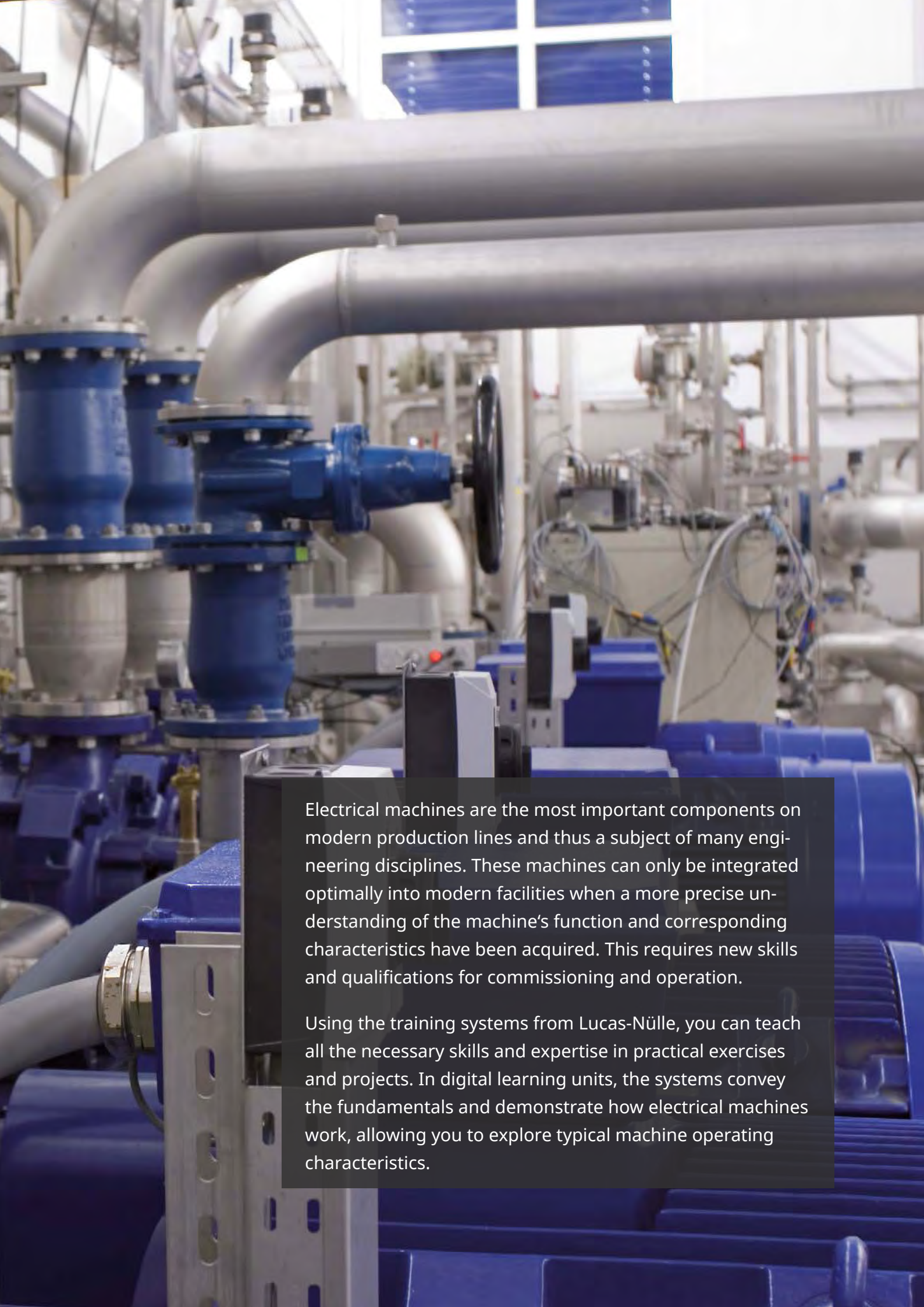
The background image shows a complex industrial environment. In the foreground, there are large, blue-painted metal valves and pipes. A prominent feature is a large black handwheel on a valve. The pipes are silver and run horizontally across the frame. In the background, there are more industrial structures, including what looks like a control panel or a piece of machinery with a red light. The overall scene is brightly lit, suggesting an indoor industrial facility.

Electrical machines are the most important components on modern production lines and thus a subject of many engineering disciplines. These machines can only be integrated optimally into modern facilities when a more precise understanding of the machine's function and corresponding characteristics have been acquired. This requires new skills and qualifications for commissioning and operation.

Using the training systems from Lucas-Nülle, you can teach all the necessary skills and expertise in practical exercises and projects. In digital learning units, the systems convey the fundamentals and demonstrate how electrical machines work, allowing you to explore typical machine operating characteristics.

DC MACHINES

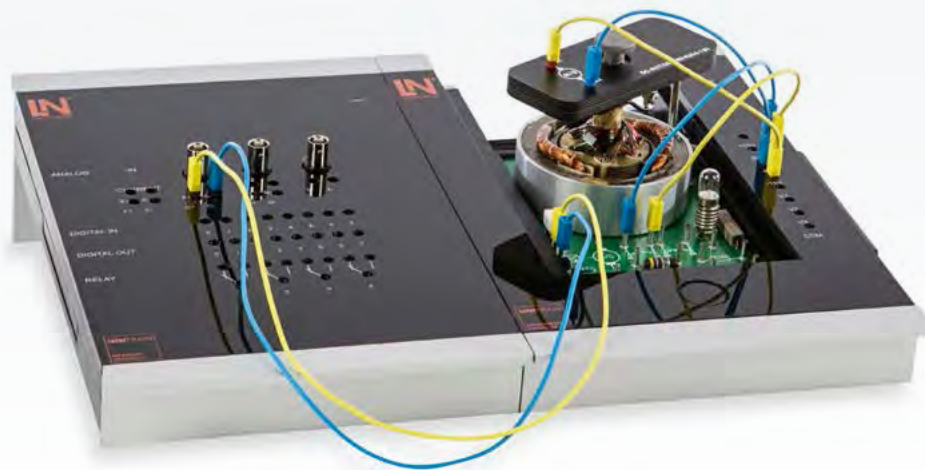

UNITRAIN SYSTEM

Shunt-wound machine - Series wound machine - Compound wound machine - Universal machine

As in the past, DC machines form the point of entry into the subject of „electrical machines“. Nowadays these motors are frequently only used in industrial applications as low-power drives with permanent excitation.

Training contents

- Shunt-wound machine - Series wound machine - Compound wound machine - Universal machine
- Connecting DC machines
- Start-up experiments
- Setting neutral zone
- Exploring the motor's response during field-weakening
- Becoming familiar with speed control methods
- Carrying out experiments on generator and braking mode

Order no. CO4204-75

ASYNCHRONOUS (INDUCTION) MACHINES



UNITRAIN SYSTEM

Squirrel-cage motor – Permanent magnet motor – Capacitor motor – Squirrel-cage rotor

Due to their immense popularity, asynchronous (induction) machines are extremely important – especially in the area of training and education.

Training contents

- How static and rotating magnetic fields arise
- Voltage and current measurements in the stator
- Connection of the stator in star or delta circuit configuration
- Various operating responses for different rotors
- Response when starting as well as in field-weakening range
- Troubleshooting

SYNCHRONOUS AND SLIP-RING ROTOR MACHINES



UNITRAIN SYSTEM

Synchronous machine – Slip-ring rotor machine – Reluctance machine

Synchronous machines are primarily used as generators for the generation of electrical energy and as highly dynamic drives (servos).

Training contents

- Explaining the technology and how it is used in actual practice
- Exploring the physics needed for understanding
- Starting machines with starter resistors and at variable frequency
- Open-loop control of speed
- Influence of open or connected rotor windings
- Effects of different excitation voltages

STEPPER MOTOR

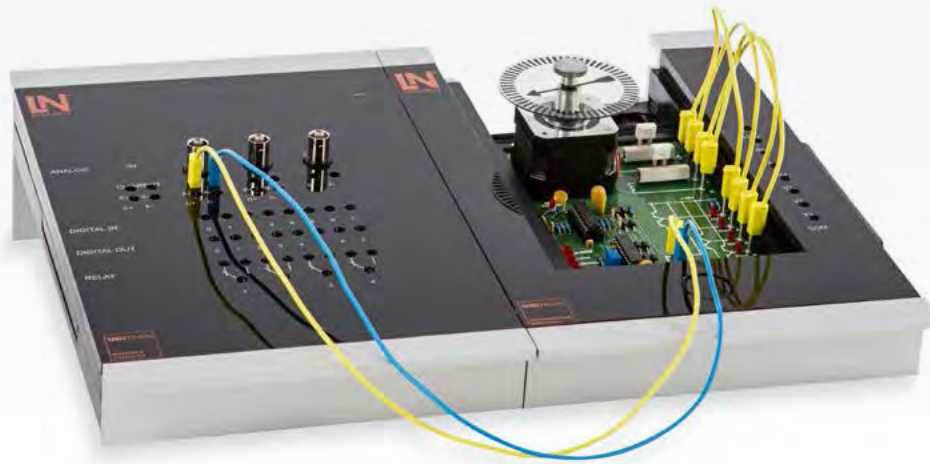
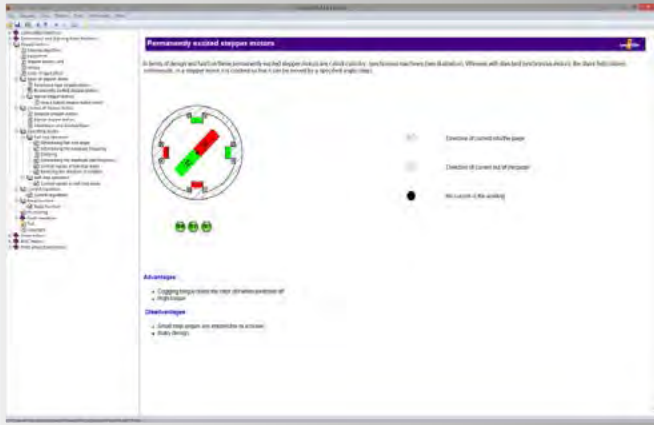

UNITRAIN SYSTEM

Construction design - Operating principle - Positioning

Stepper motors permit a cost-efficient solution for positioning assignments. For that reason, they are manufactured in huge numbers for a variety of industrial applications.

Training contents

- Clarification of stepping motor technology using animations, theoretical information and experiments
- Control operation principles
- Demonstrate the differences between the two current limiting methods
- Limits of the stepper motor
- Complex positioning assignments

BLDC/SERVO MOTOR



UNITRAIN
SYSTEM

Operation - Position Detection - Closed-loop Control

Brushless DC motors (BLDC) are used in the widest range of areas and applications. BLDC motors have a high degree of efficiency and operate like permanently excited synchronous motors.

Training contents

- Design and function of the motor and the control electronics
- Investigation of the pick-up system
- Investigation of how the motor is powered
- Design of a torque- and speed-controlled drive

Order no. CO4204-7Z

LINEAR MOTOR

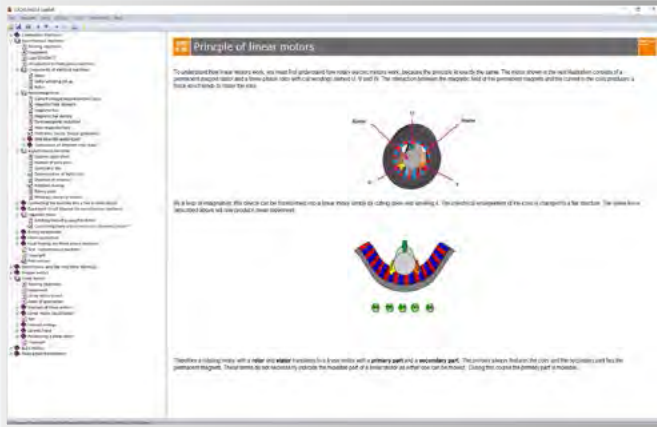

UNITRAIN SYSTEM

Function – Applications – Positioning

Linear motors are used very effectively whenever there is an application requiring linear motion to be carried out. Also in modern automation applications, linear motors have become indispensable

Training contents

- Design, function and operating response of linear motors
- Meaning of the terms „Lorentz force“ and „induced voltage“
- Application areas of linear motors
- Different designs of linear motors
- Determining motor constants
- Positioning with a linear motor
- Methods of detecting position (encoders, Hall sensors)
- Determining position with the aid of analog Hall sensors

THREE-PHASE TRANSFORMER

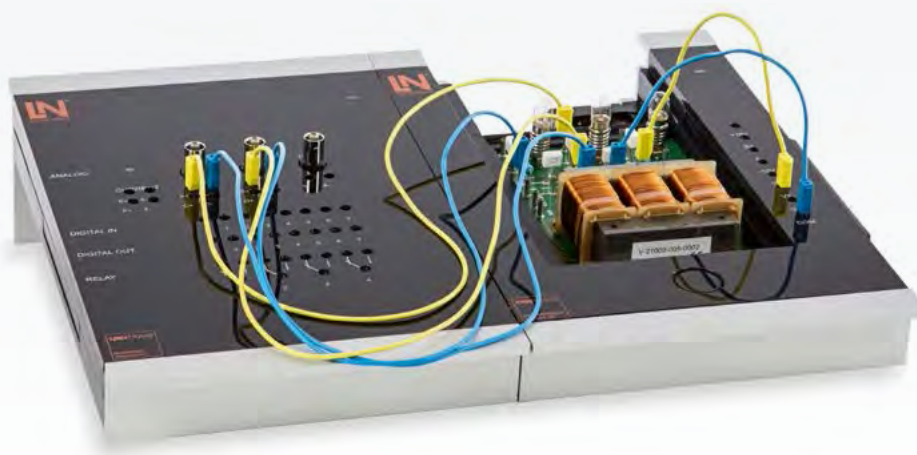

UNITRAIN SYSTEM

Design - Connection types - Load response

Transformers are electrical machines designed to convert AC or three-phase currents to higher or lower voltages. Three-phase transformers are particularly important in the transmission of electrical power.

Training contents

- Becoming familiar with the transformer principle and the equivalent circuit diagram
- Recording current and voltage with and without load
- Investigating the transmission ratio
- Investigating load cases for various vector groups
- Investigating unbalanced loads connected to various vector groups
- Determining the short-circuit voltage

ELECTROMAGNETIC COMPATIBILITY

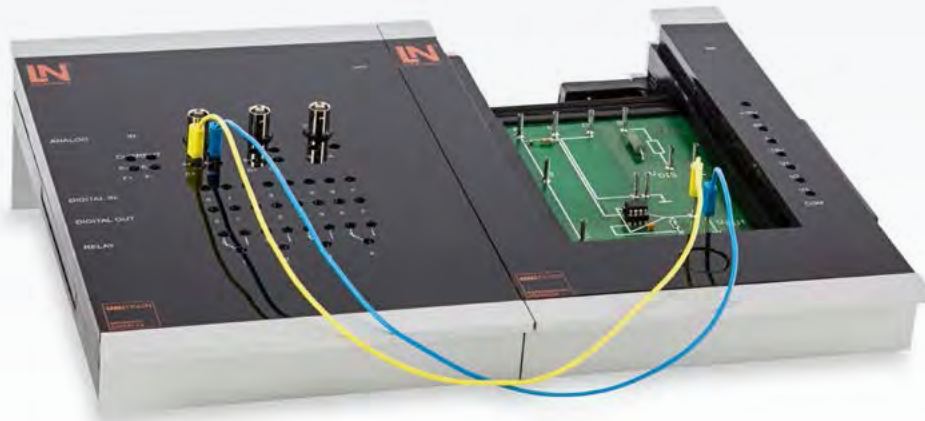
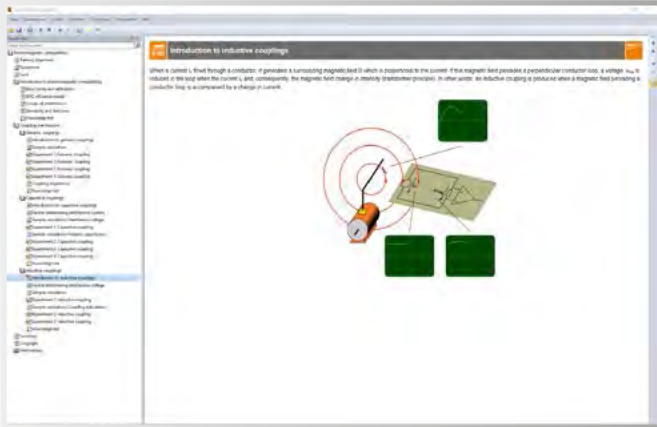

UNITRAIN SYSTEM

Coupling effect – Interference immunity – Standards

Aspects of a circuit's electromagnetic compatibility play a significant role in development and fault analysis. This involves coupling effects inside the circuit and also signal interference.

Training contents

- Concept of electromagnetic compatibility, EMC
- Description of electromagnetic coupling effects
- Investigating galvanic, inductive and capacitive coupling between conductor paths
- Measures taken to improve a circuit's EMC properties
- Measures taken to boost a circuit's immunity to interference

MANUFACTURING SINGLE-PHASE AND THREE-PHASE TRANSFORMERS



The manufacturing of transformers is the focal point of this training system. This covers the hands-on training of the design and function of transformers. The training system contains all the components and tools needed for the manufacture of transformers. Most of the components are reusable so that after the experiment is carried out with the transformer, it can be disassembled again. In additional experiments, it is possible to investigate the transformer's operating response in conjunction with different loads.

Training contents

- Design and function of single-phase and three-phase transformers
- Calculation of winding data
- Manufacture of windings
- Transformer operational test according to standards
- Various operating responses to different loads and vector groups

MANUFACTURE OF A THREE-PHASE MOTOR WITH SQUIRREL-CAGE



The training system provides instruction on the coil windings of a three-phase motor with a squirrel-cage rotor. In the process, windings are wound in coils. These coils are inserted into the stator and the connection is completed. A fully functional motor is produced. That way a hands-on, practical understanding of the design and function of a motor is taught. The training system contains all the components and tools needed to manufacture a three-phase asynchronous (induction) motor. Most of the components can be reused after the experiments have been performed. In further experiments, various operating responses can be investigated using the machine test stand.

Training contents

- Electrical and mechanical design of the motor
- Determining the winding data
- Manufacture of windings
- Inserting and wiring the windings
- Operation testing of the motor according to standards
- Connection, wiring and putting into operation
- Recording of the speed-torque operating response

DC MACHINES



300 W and 1 kW classes available

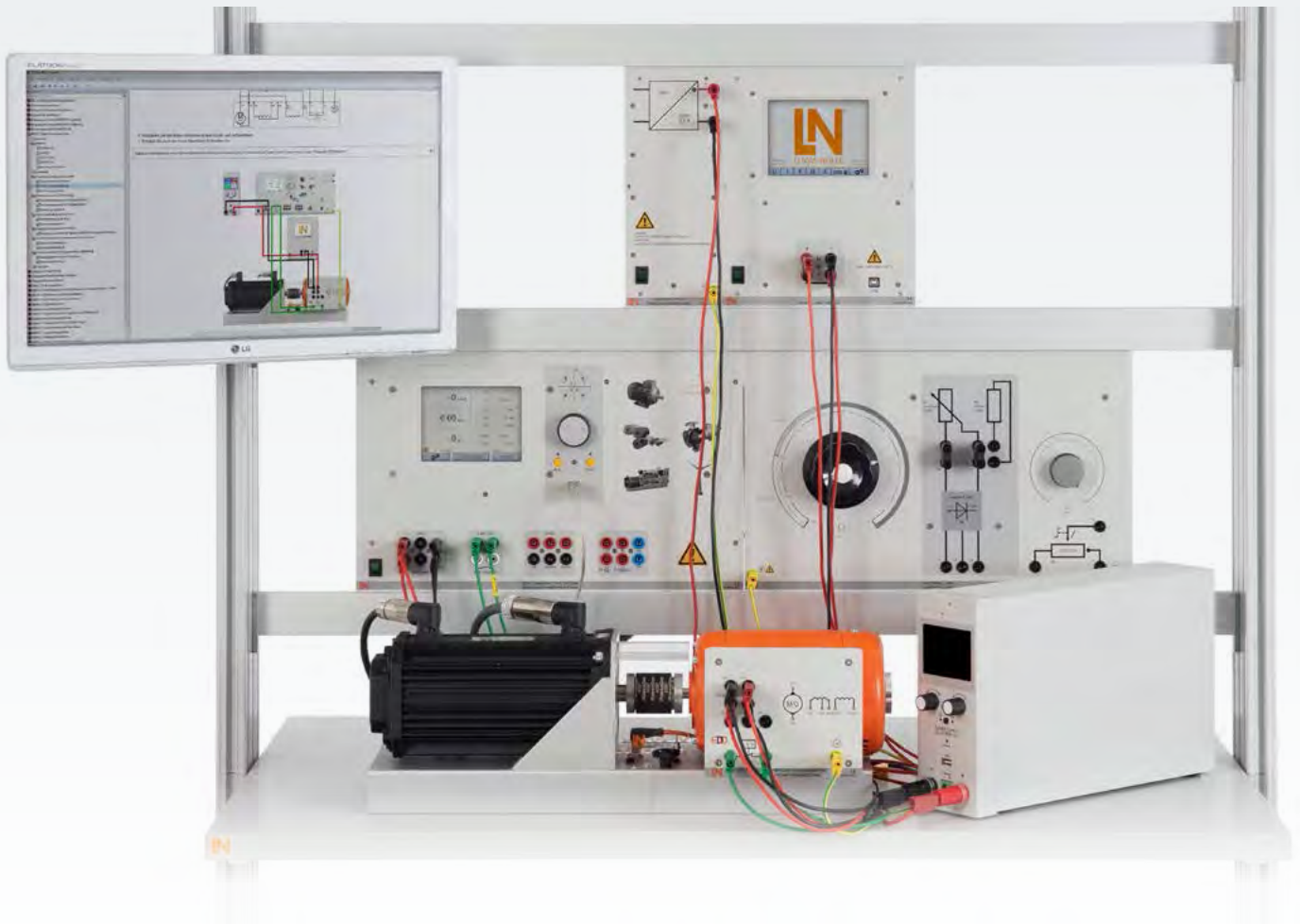

Shunt-wound machine – Series-wound machine – Compound wound machine

DC machines continue to form the foundation of vocational training in the area of electrical machines. They are used to clearly and concisely demonstrate the potential of open- and closed-loop control techniques.

Training contents

- **Motor operating mode**
 - ' Motor connection
 - ' Comparing various machine types
 - ' Typical machine data and characteristics
 - ' Speed control with starter and field regulator
 - ' Reversing rotation direction
- **Generator operating mode**
 - ' Generator connection
 - ' Armature voltage as a function of excitation current
 - ' Function and use of the field regulator
 - ' Self-excited and separately excited voltage control
 - ' Load diagrams of the generator

UNIVERSAL MOTOR



300 W and 1 kW classes available

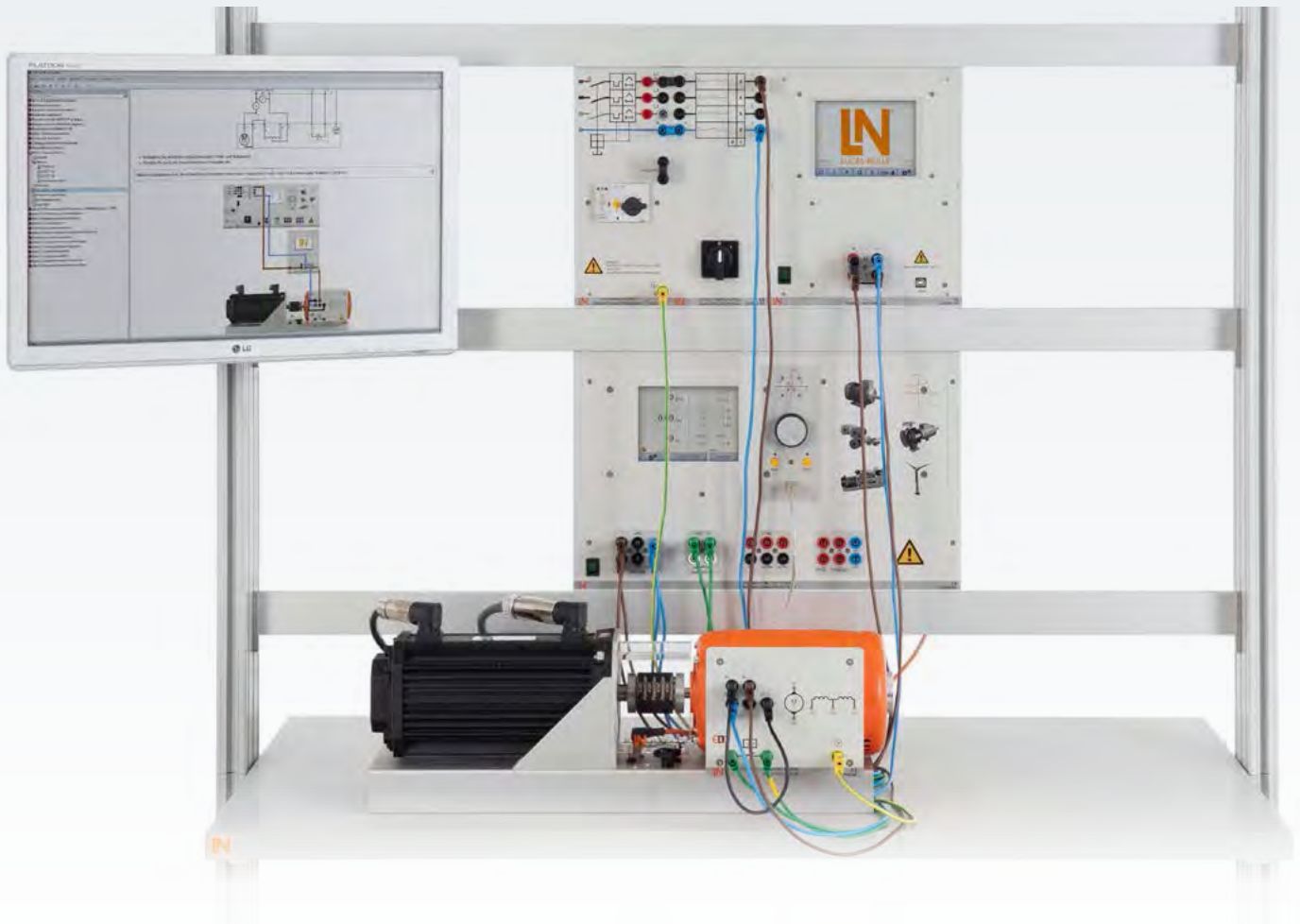

Universal motor

Universal motors are static converter machines and serve as drives for electrical tools and household appliances. They feature a power level of up to around 2 kW. Thanks to their simple speed control, universal motors make up a significant proportion of all AC machines.

Training contents

- Connection, wiring and putting into operation
- Reversing rotation direction
- Operation with AC and DC voltage
- Recording of the speed-torque operating response
- Operation with various load machinery like e.g. ventilators

SINGLE-PHASE MOTOR WITH BIFILAR STARTER WINDING



300 W and 1 kW classes available

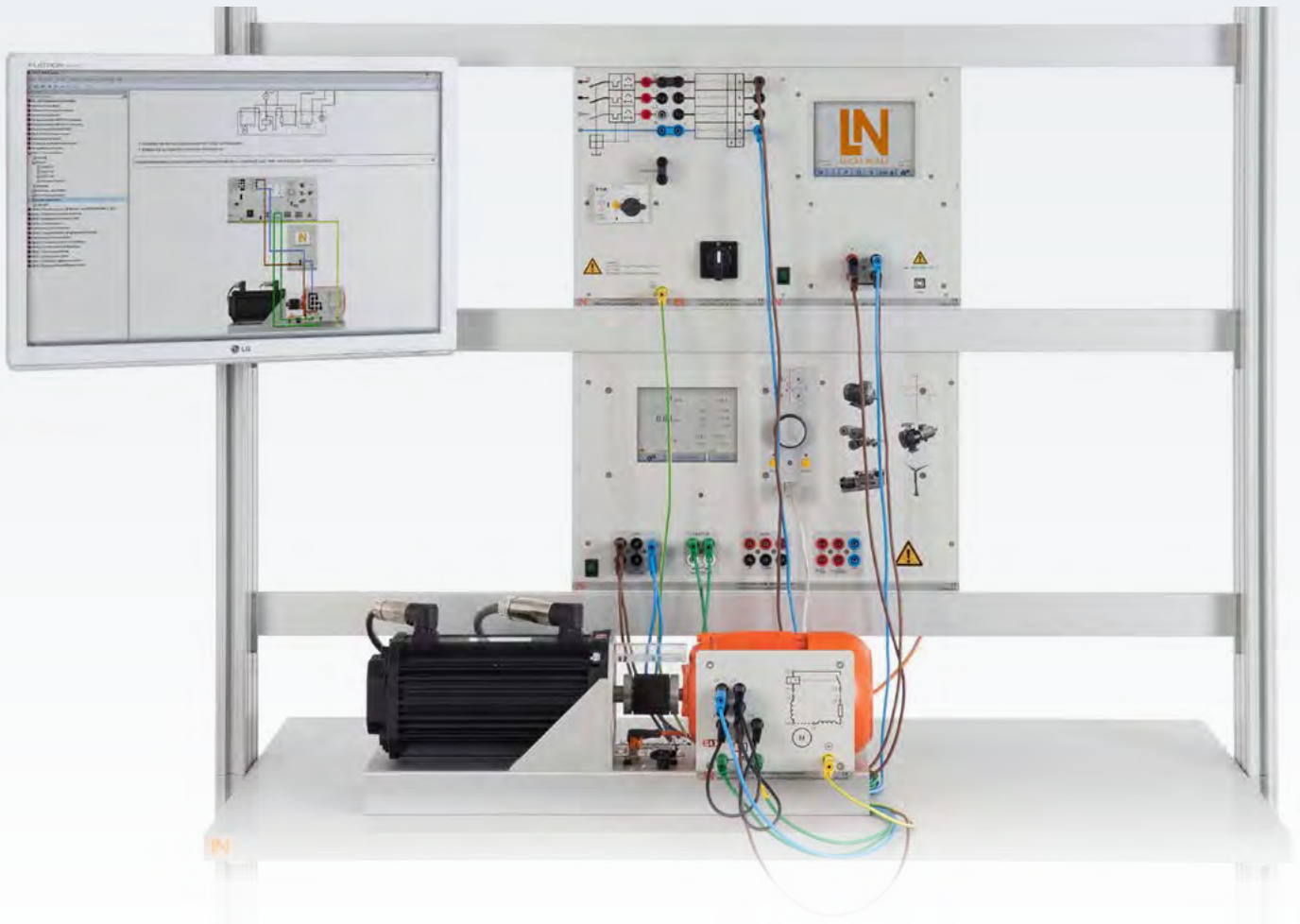

Single-phase motors with bifilar starter winding are asynchronous (induction) machines. Besides a primary winding, they have a starter winding with high internal resistance, which is partially bifilar designed and thus magnetically ineffective. It is disabled after start-up. The motors do not contain any parts which are subject to wear and tear such as collectors or slip-rings and operate with fixed, almost synchronous speed. The power range can reach up to around 2 kW..

Training contents

- Connection, wiring and putting into operation
- Reversing rotation direction
- Recording of the speed-torque operating response
- Operation with various load machines such as ventilators

SINGLE-PHASE MOTOR WITH OPERATING AND STARTING CAPACITOR



300 W and 1 kW classes available

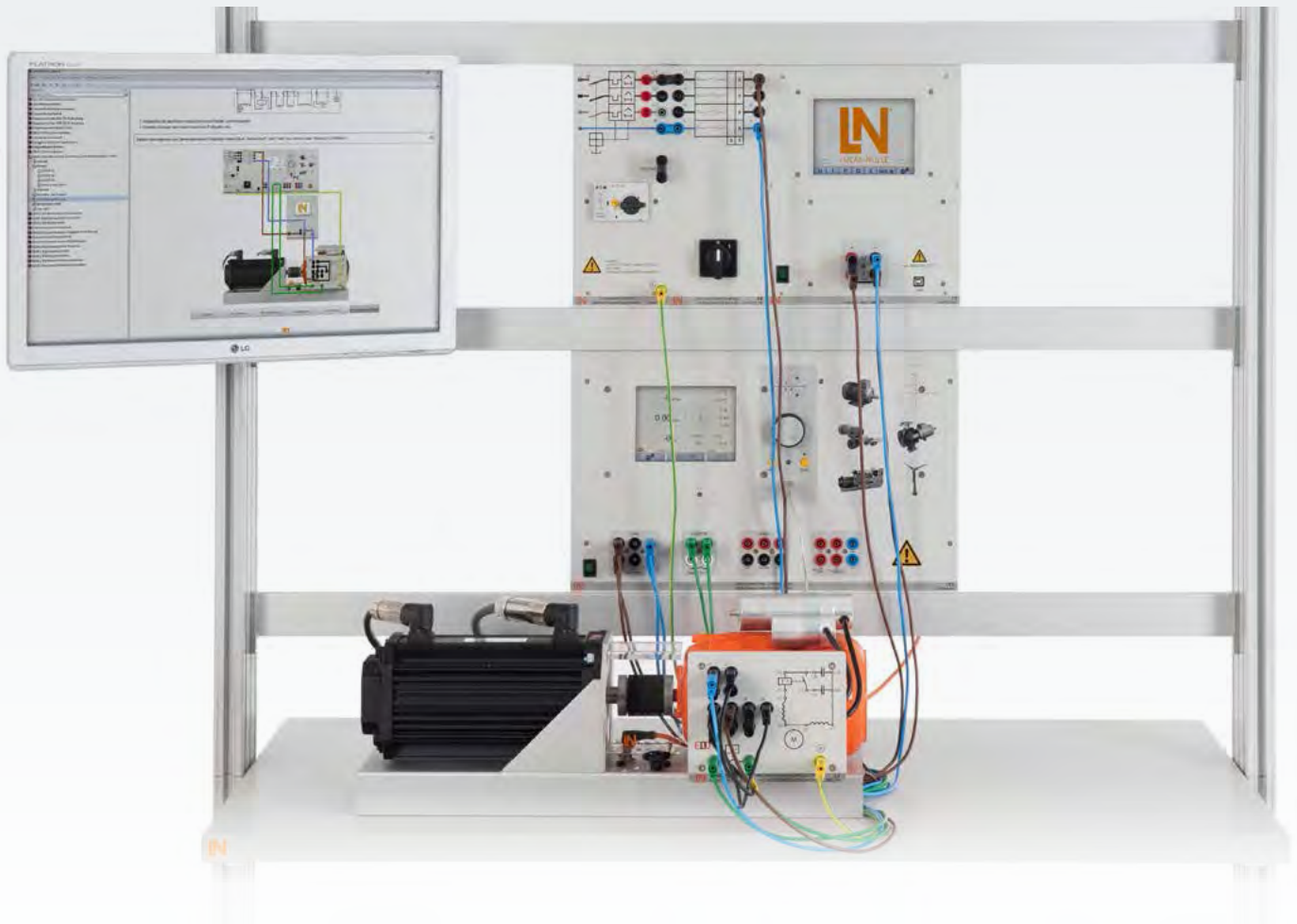

Single-phase motors with operating and starting capacitors are asynchronous (induction) machines. In addition to the primary winding, they have an auxiliary winding connected in series to the capacitor. The motors do not contain any parts subject to wear and tear like collectors or slip-rings and operate at an almost synchronous rotation speed. The power range reaches up to around 2 kW. Capacitor motors are used to operate household appliances, refrigerators and even small drives used in production machinery.

Training contents

- Connection, wiring and putting into operation
- Reversing rotation direction
- Operation with and without starting capacitor
- Recording of the speed-torque operating response
- Start-up with and without starting capacitor
- Investigating current relays

ENERGY-SAVING MOTORS



300 W and 1 kW classes available

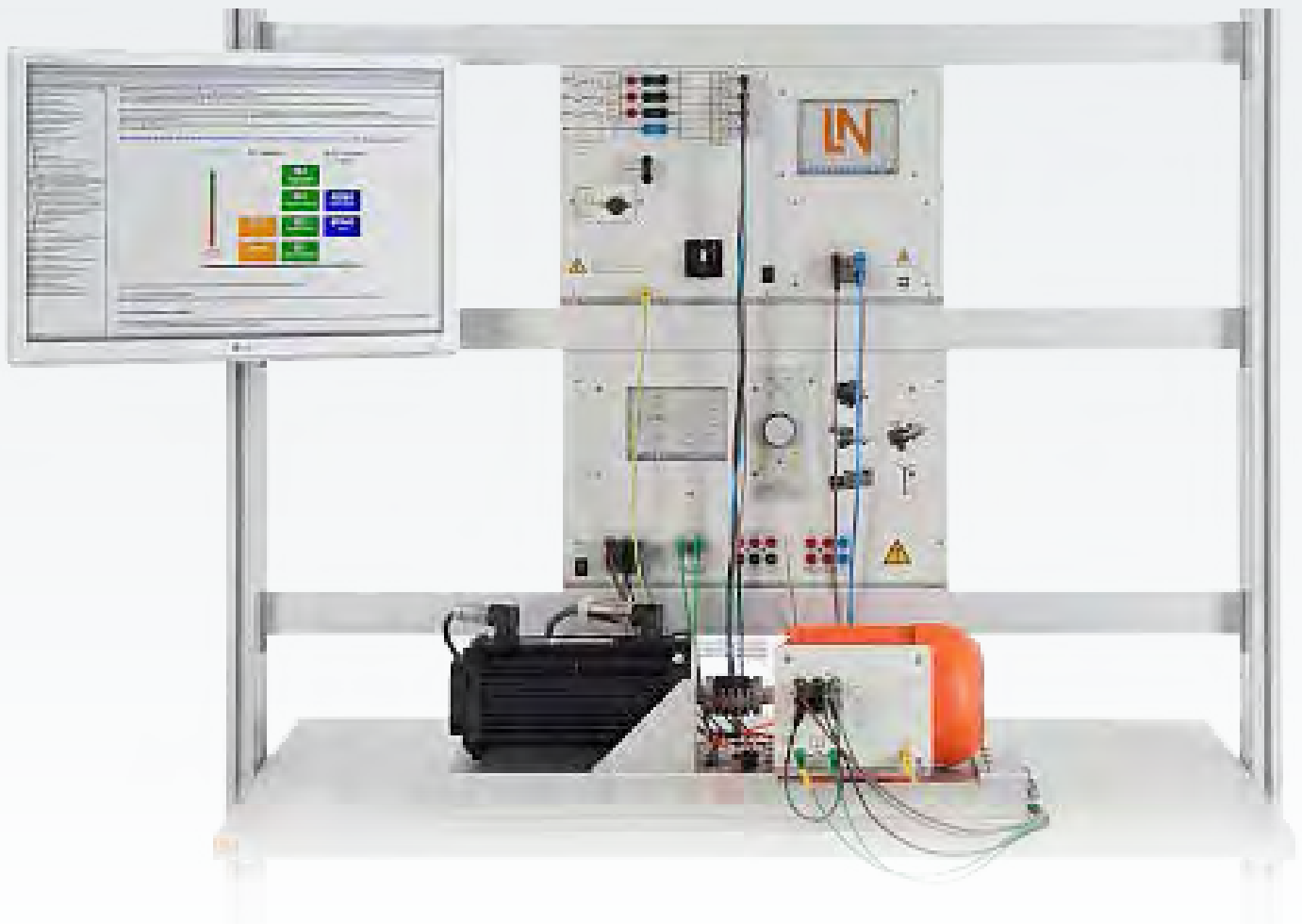

One of the world's greatest challenges today and in the future is how to save energy. In the world of automation there is scarcely a single area that is not powered by electrical drives. It is due to this prevalence and broad application spectrum that this area constitutes such an effective lever in boosting energy efficiency.

Training contents

- Design and operation of energy-saving motors
- Classes of energy-efficient motor
- Comparing energy-efficient motors to standard motors
- Operating characteristics of energy-saving motors
- Determining the potential for energy-savings

SQUIRREL-CAGE MOTOR



300 W and 1 kW classes available

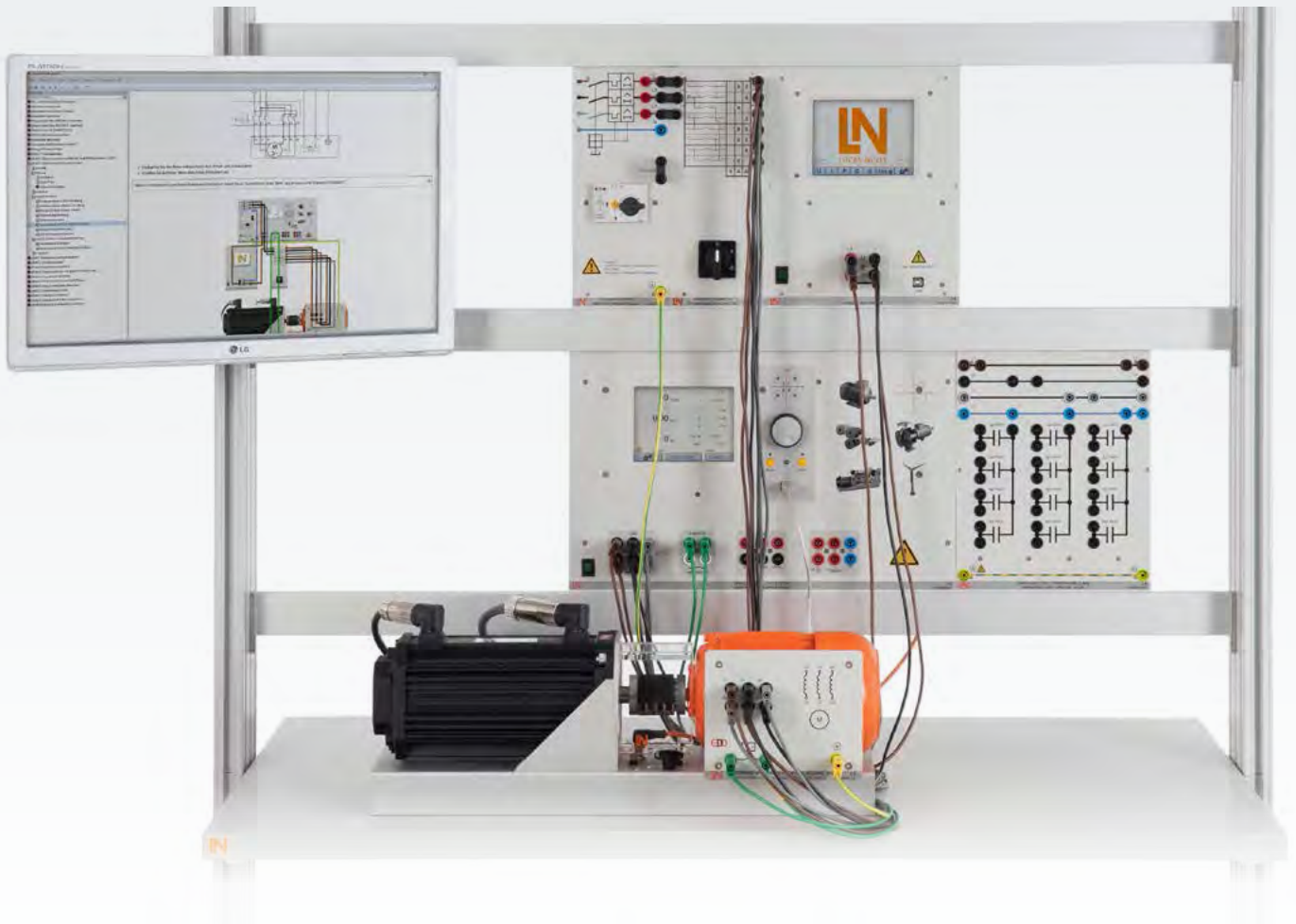

Three-phase motors with squirrel-cage rotors are the most frequently used in industry. The maintenance-free and rugged motors can be manufactured cost-efficiently. These motors can be found ranging from low power levels in the watt range up to power levels of several megawatts. Thanks to the use of modern frequency converter technology, these motors can vary their speeds virtually loss-free so that there appears to be no end to new application areas for these motors.

Training contents

- Connection, wiring and putting into operation
- Operation in star and delta circuit configuration
- Use of a star-delta switch
- Recording of the speed-torque operating response
- Operation with various load machines such as ventilators, hoisting machinery

DAHLANDER POLE-CHANGING MOTOR



300 W and 1 kW classes available



Thanks to its special winding, the three-phase motor with Dahlander circuit is able to operate the motor with squirrel-cage rotor at two different speeds. The ratio of speeds is 2:1 for this circuit. With this motor type, simple drives can be designed with two speeds, for example, a two-staged ventilator drive.

Training contents

- Connection, wiring and putting into operation
- Operates at high and low speed
- Use of a pole-changing switch
- Recording of the speed-torque operating response
- Operation with various load machines like e.g. ventilators, lifting equipment

Order no. EEM 4.2

THREE-PHASE MOTORS WITH TWO SEPARATE WINDINGS



300 W and 1 kW classes available

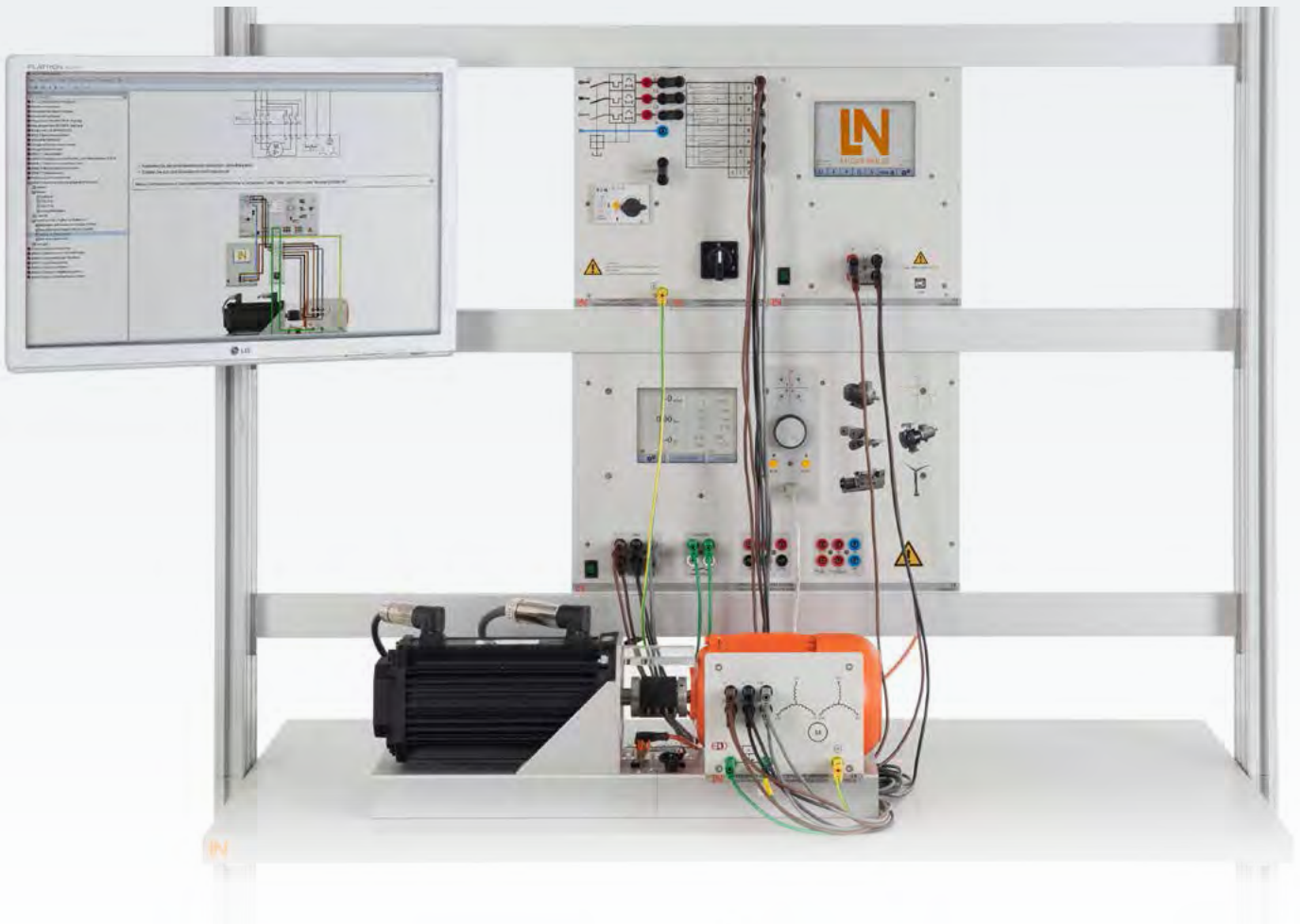

The system consists of two three-phase motors in a single housing with separate windings. Since both windings operate separately from each other, different integer ratios can be produced between the speeds. The motor is used for simple applications wherever the ratio between slower and faster speed is greater than two, for example in crane applications with creep speed and high speed.

Training contents

- Connection, wiring and putting into operation
- Operates at high and low speed
- Use of a pole-changing switch
- Recording of the speed-torque operating response
- Operation with various load machines such as ventilators, hoisting machinery

THREE-PHASE MOTOR WITH SLIP-RINGS



300 W and 1 kW classes available

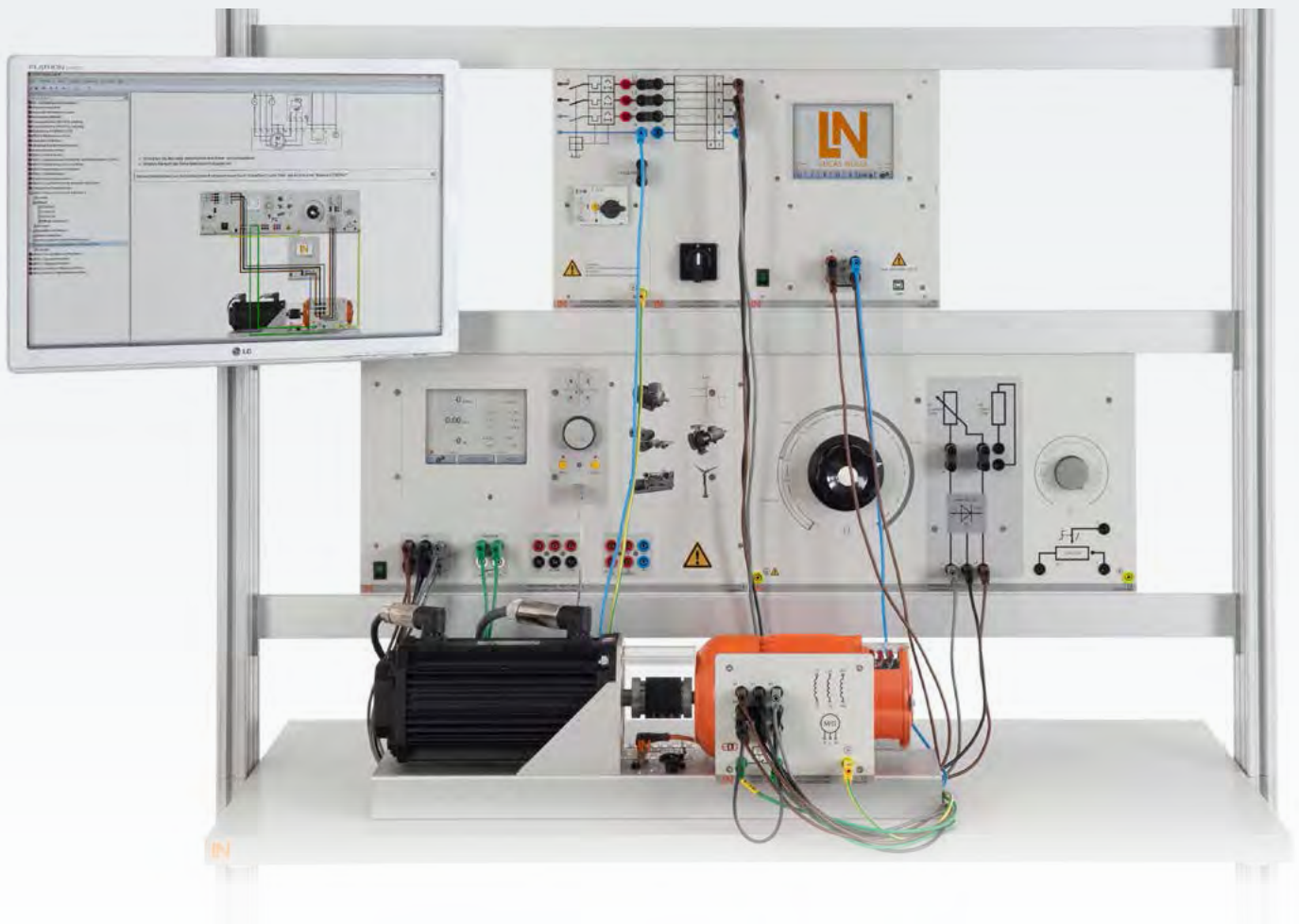

In contrast to squirrel-cage rotors, slip-ring rotors have a rotor equipped with wound coils. These can be connected to resistors or static converters via slip-rings. Speed adjustment is performed via these connection terminals.

Training contents

- Connection, wiring and putting into operation
- Speed adjustment by modifying the resistance across the rotor
- Recording of the speed-torque operating response
- Operation with various load machines such as ventilators, hoisting machinery

Order no. EEM 4.4

TROUBLE-SHOOTING ON ELECTRICAL MACHINES



The fault simulator can be simply plugged into a three-phase asynchronous machine. Thanks to the lockable fault switches, a wide variety of typical faults can be activated. These can be found and analyzed using measuring equipment routinely found in industrial applications. Repair strategies can be derived based on the measurement results. All measurements are undertaken with the equipment de-energized.

Training contents

- Winding breaks in coils
- Winding to winding insulation fault
- Winding to housing insulation fault
- Combination of different faults
- Fault assessment and practical repair instructions
- Proper handling of insulation meters

PROTECTION OF ELECTRICAL MACHINES



300 W and 1 kW classes available



Squirrel-cage motors are designed to operate at constant load. Changes in the load state but also high starting currents can lead to the impermissible and excessive overheating of the motor. Sensors monitor the motor's temperature and current consumption. They activate protective circuitry like motor circuit-breakers, motor protective relays or thermistor relays.

Training contents

- Selection, installation and configuration of various motor protection systems
- Motor circuit-breaker
- Motor protection relay
- Thermistor protection
- Effect of various operating modes on the heat build-up in the motor
- Tripping characteristics of the protection systems
- Protection against impermissible operating states

MANUAL SWITCHING IN THE THREE-PHASE CIRCUIT



The focus of this training section is the development of circuitry and the correct selection of switching elements and devices. Multi-pole motors can be connected up to a certain power class directly in the three-phase circuit. To do this, there is the appropriate switching equipment for every application and purpose.

Training contents

- Manual switching in the three-phase circuit
- Contactor circuitry in the three-phase circuit
- Switching off a three-phase induction motor with squirrel cage
- Star-delta circuit of a three-phase induction motor with squirrel cage
- Star-delta reversing circuit of a three-phase induction motor with squirrel cage
- Pole-changing control of three-phase induction motor according to Dahlander
- Pole-changing control of three-phase induction motor with two separate windings

CONTACTOR CIRCUITRY IN THE THREE-PHASE CIRCUIT



300 W and 1 kW classes available



As of a certain power class, it is no longer possible to switch three-phase machines directly. For that reason, the switching of these machines is performed using contactor circuits of a wide variety. The focal point of this training is on the development of control circuitry and how to design functional controls. With the supplementary equipment sets, additional and more extensive control operations can be explored. The machine equipment set contains all the necessary motors and equipment needed to test the circuitry used for direct and indirect control of motors in the three-phase circuit.

Training contents

- Selection, installation and configuration of various motor protection systems
- Motor circuit-breaker
- Motor protection relay
- Thermistor protection
- Effect of various operating modes on the heat build-up in the motor
- Tripping characteristics of the protection systems
- Protection against impermissible operating states

Order no. EST 2

SYNCHRONOUS MACHINES



300 W and 1 kW classes available

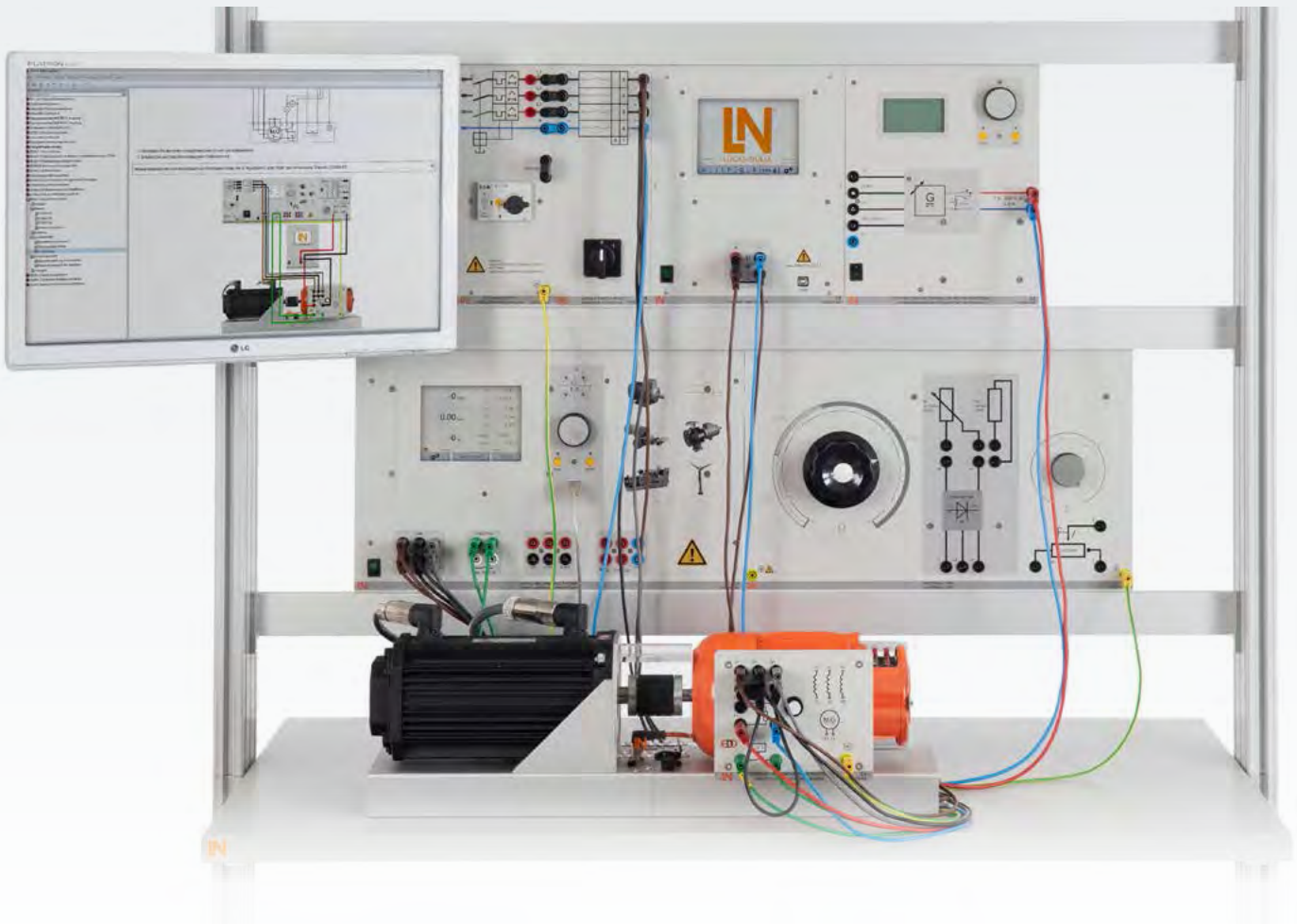

Synchronous machines are primarily deployed as generators supplying electrical power. For this purpose, their power levels can reach up to approx. 2000 MVA. Additional application areas include large-scale drives for cement mills and conveyor belt systems with power levels in the megawatt range. Highly dynamic servos with permanently excited rotor rounds off the scope of synchronous machines. In contrast to asynchronous (induction) machines, the rotor here runs synchronously with the rotating field.

Training contents

Motor operation:

- Motor connection
- Starting
- Phase-shifter operation
- Load characteristics in motor operation
- V characteristics
- Stability limits
- Underexcitation and overexcitation

Generator operation:

- Generator connection
- Setting the voltage via the excitation current
- Load characteristics in generator operation

Order no. EEM 5.1

MAINS SYNCHRONIZATION



300 W and 1 kW classes available

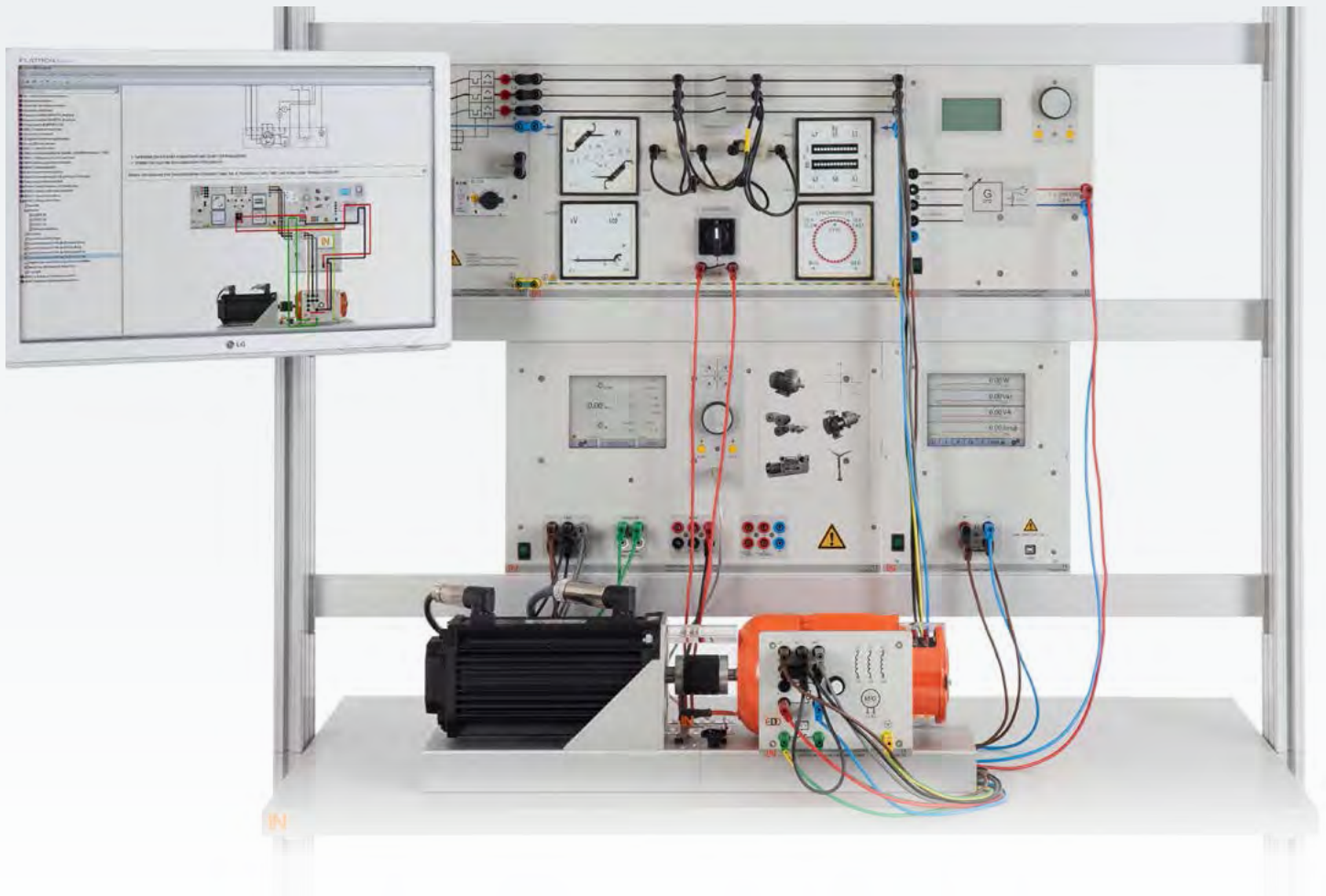

In mains synchronization, the unloaded generator is connected to the mains power grid. Voltage, frequency and phase-angle have to coincide with the corresponding variable on the mains power grid. To measure these variables, a variety of different measuring instruments are used. The variables are set by means of the generator speed and generator excitation.

Training contents

- Manual mains synchronization is performed using the bright method, dark method and three-lamp synchronization circuits
- Mains synchronization using the two-range frequency meter, two-range voltmeter,
- Synchronoscope and zero-voltage meter
- Influence of generator speed
- Influence of generator excitation
- Adjusting energy flow by means of the drive

Order no. EEM 5.2

THREE-PHASE RELUCTANCE MACHINE



300 W and 1 kW classes available

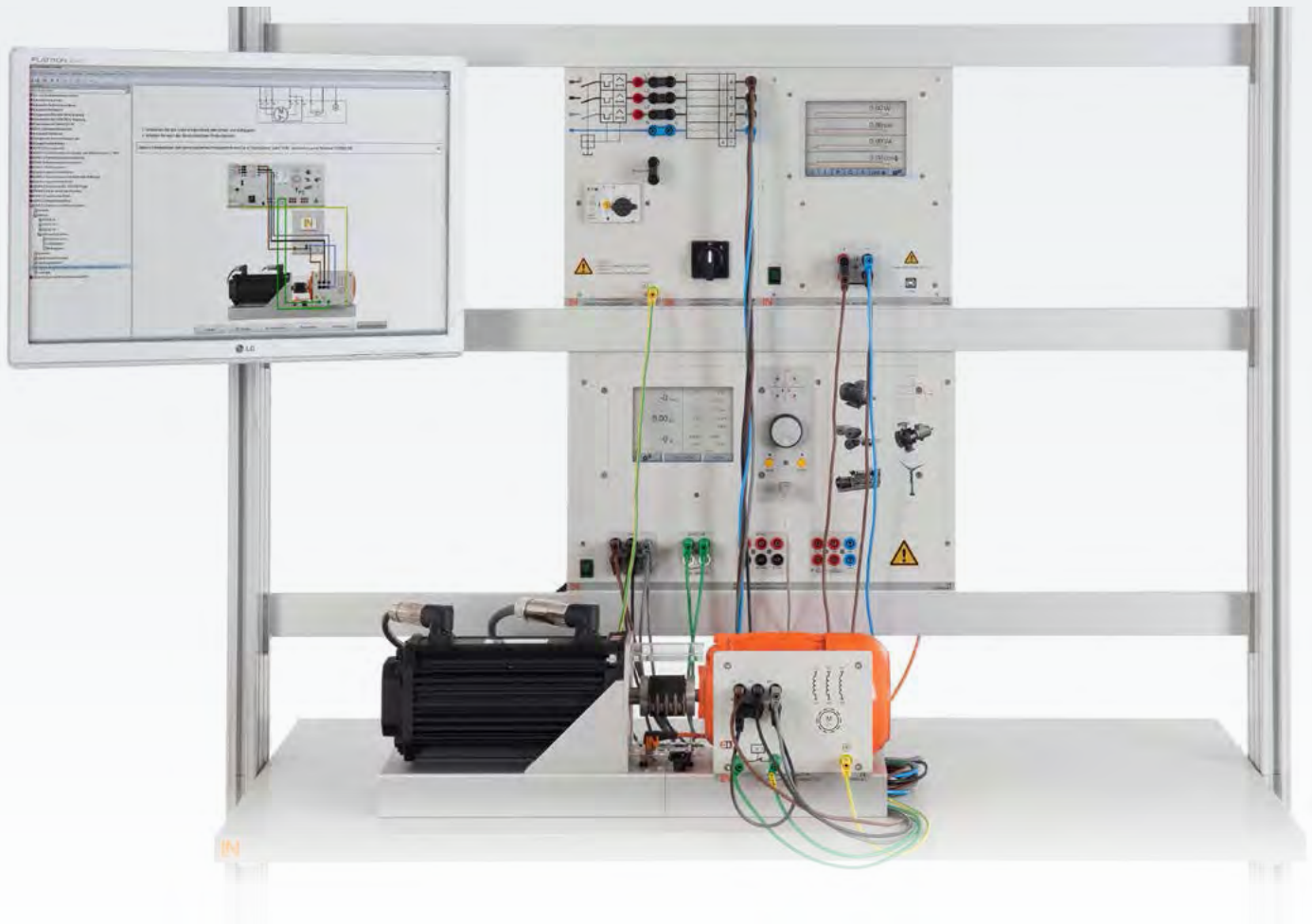

Reluctance motors are a mixture of asynchronous and synchronous motor. Thanks to the special rotor design with salient poles, the motor can start like an asynchronous motor. After a certain speed is reached, the rotor runs synchronously with the stator field. Reluctance machines are used for example in the textile industry for the synchronous de-spooling of yarn. This entails several motors being controlled by one frequency converter.

Training contents

- Connection, wiring and putting into operation
- Reversing rotation direction
- Recording of the speed-torque operating response

ONE STATOR, VARIOUS ROTORS

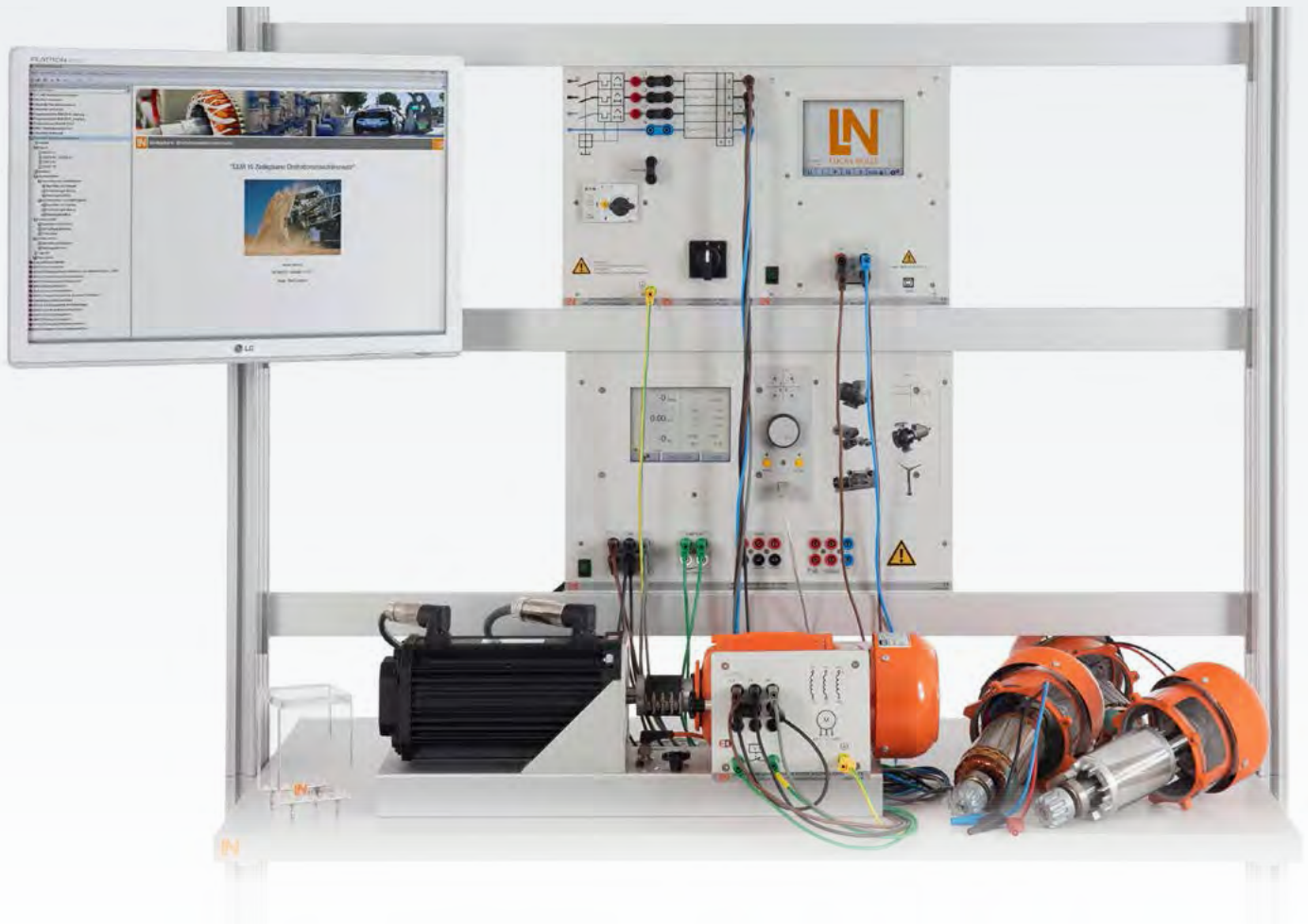

This training system comprises one uniform stator for all machine types and a set of interchangeable rotors. Thanks to its dismountable design, this set is particularly well suited for teaching fundamentals because it facilitates the exploration of the construction designs and differences between the various machines.

Unlike conventional cut-out models, these machines are fully operational and can be coupled to the machine test system.

Training contents

Design and construction differences between the three-phase machines and connection, putting into operation and recording characteristics of:

- Squirrel-cage rotors
- Synchronous machines
- Slip-ring rotors
- Reluctance machines

SINGLE-PHASE AND THREE-PHASE TRANSFORMERS



Transformers make it possible to convert currents and voltages. Sometimes called passive electrical machines, these are used to adapt designated equipment to the different voltage levels made available by the power industry. The power levels can be over 1000 MVA. Small transformers can be found everywhere in industry and in the consumer goods sector. The power levels range from the smallest construction size up to transformers used to serve entire factory systems.

Training contents

- Isolation and autotransformers
- Equivalent circuit diagrams
- Transformation ratios
- No-load and short-circuit experiments
- Vector groups in three-phase transformers
- Design and operation of transformers
- Single-phase transformer
- Three-phase transformer

POWER ELECTRONICS AND DRIVES DESIGNED FOR EDUCATIONAL PURPOSES





The rapid development taking place in power semiconductors continues to forge ever newer applications and improvements in electrical drives. Modern converter-controlled drives and networked PLCs form the backbone of the smart factory and industry 4.0.

The training systems from Lucas-Nülle allow students to explore the technical relationships starting with static converter technology and also include automatically controlled DC and frequency converter drives. The systems with their well-conceived software are designed to provide optimum support in quickly putting the systems into operation. Digital learning units ensure learning success.

LINE-COMMUTATED STATIC CONVERTERS

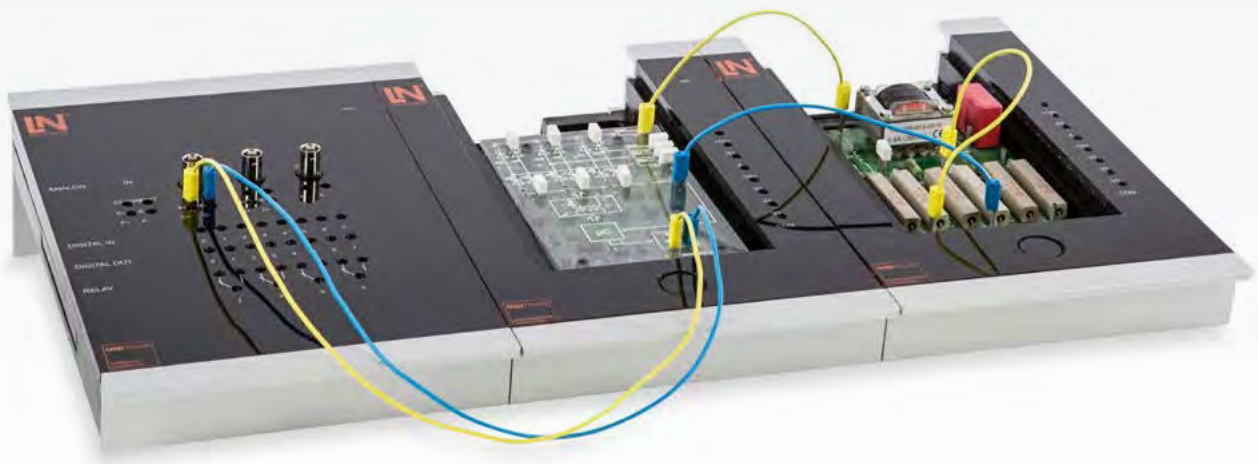

UNITRAIN SYSTEM

Uncontrolled rectifiers – Controlled rectifiers – AC and three-phase AC controllers

Power electronics is firmly established in modern life. Without it, such things as dimmable lights, speed-variable drills or electric heaters would be impossible. It is the use of power semiconductors like diodes, thyristors and power transistors that make this possible.

Training contents

- Design and operation of single-phase and three-phase rectifiers
- Operating characteristics on uncontrolled, semi-controlled and fully-controlled static converter circuits
- Power semiconductors and their control
- Measurement variables in power electronics
- Measurement and analysis of static converter circuit power
- Analysis of current, voltage and power using fast Fourier transform analysis (FFT)

SELF-COMMUTATED STATIC CONVERTERS

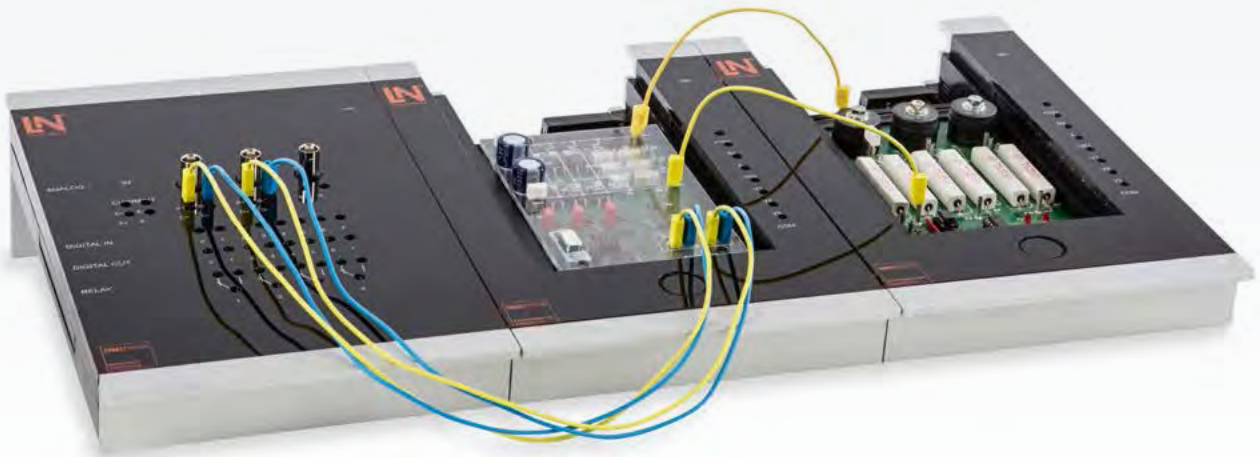

UNITRAIN SYSTEM

PWM - 4-quadrant controller - Power inverter

The number of speed-variable drives used in modern machinery continues to increase steadily. The reason for this is ever-increasing demands combined with the use of more modern, cost-effective converters. These converters operate today with PWM technology.

Training contents

- PWM for the generation of variable DC and AC voltage
- Recording of control and operating characteristics
- Design and operation of three-phase power inverters
- Block commutation, sinusoidal, super-sine and space vector modulation for the generation of voltage- and frequency-variable voltages
- Instrumentation-based analysis of different modulation methods based on signal curve measurements and fast Fourier transform analysis (FFT)

Order no. CO4204-7M

FREQUENCY CONVERTER DRIVES

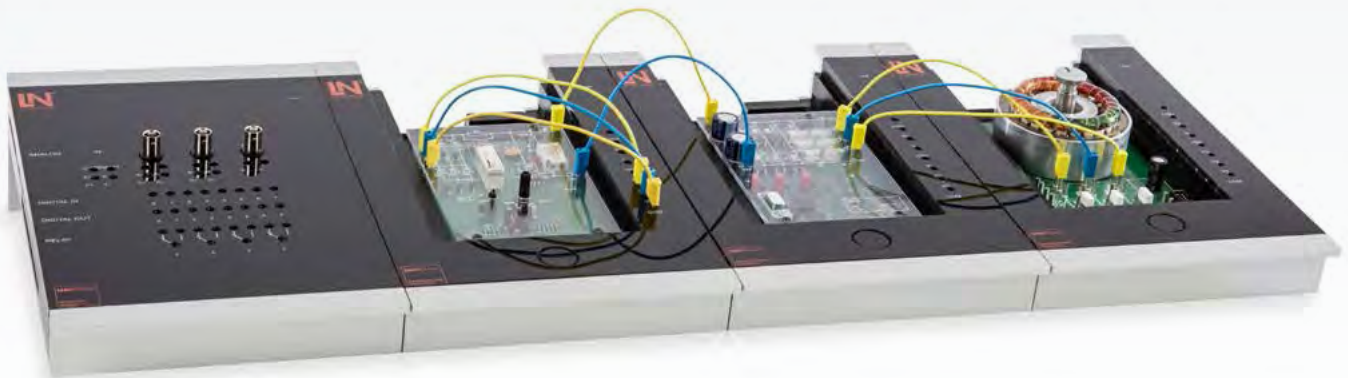

UNITRAIN SYSTEM

Frequency converter drives permit low-loss, continuous speed adjustment of three-phase asynchronous motors. In addition to pure motor control and motor protection functions, modern frequency converters nowadays also perform some of the process automation operations.

Training contents

- Design of modern frequency converters
- Generation of the DC link voltage
- Recording U / f characteristics
- Design and operation of brake choppers
- Optimization of speed-controlled drives
- Becoming familiar with „87 Hz technology“
- Recording and analysis of currents, voltages and power levels

Order no. CO4204-7P

ACTIVE POWER FACTOR CORRECTION PFC

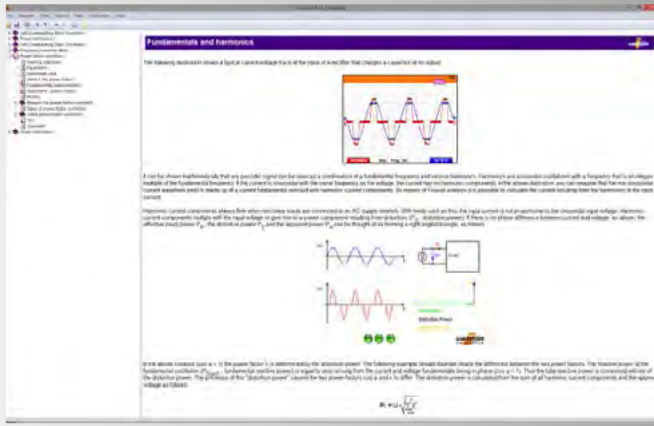

UNITRAIN
SYSTEM

Today every mains power supply built into a computer is equipped with power factor correction (PFC). The reason why this is so popular is a European-wide standard which stipulates that loads above a certain power level have to draw their current from the mains grid in a linear relationship to their voltage characteristic.

Training contents

- Active and passive power factor correction
- Design and operation of an active power factor correction circuit
- Application areas of power factor correction
- Comparison with conventional bridge rectifier circuits
- Recording and analysis of currents, voltages and power levels (also using FFT)

Order no. CO4204-7Q

LINE-COMMUTATED CONVERTER CIRCUITS



300 W and 1 kW classes available



Line-commutated converters permit power to be fed from an AC or three-phase system to a DC circuit. These can be designed for operation in controlled mode using thyristors and triacs or uncontrolled mode using diodes.

Training contents

- Diode, thyristor, triac fundamentals
- Control principles: phase-angle control, full-wave control, burst-firing control, pulse-pattern control, rectifier operation, power inverter operation
- Converter circuits: M1, M2, M3, B2, B6, M1C, M2C, M3C, B2C, B6C, B2HA, B2HK, B2HZ, B6C, B6HA, B6HK, W1C, W3C
- Resistive, capacitive and inductive load
- Control characteristics and operating graphs
- Frequency analysis and examination of harmonics

Order no. EPE 30

CONVERTER DRIVES WITH DC MOTORS



300 W and 1 kW classes available

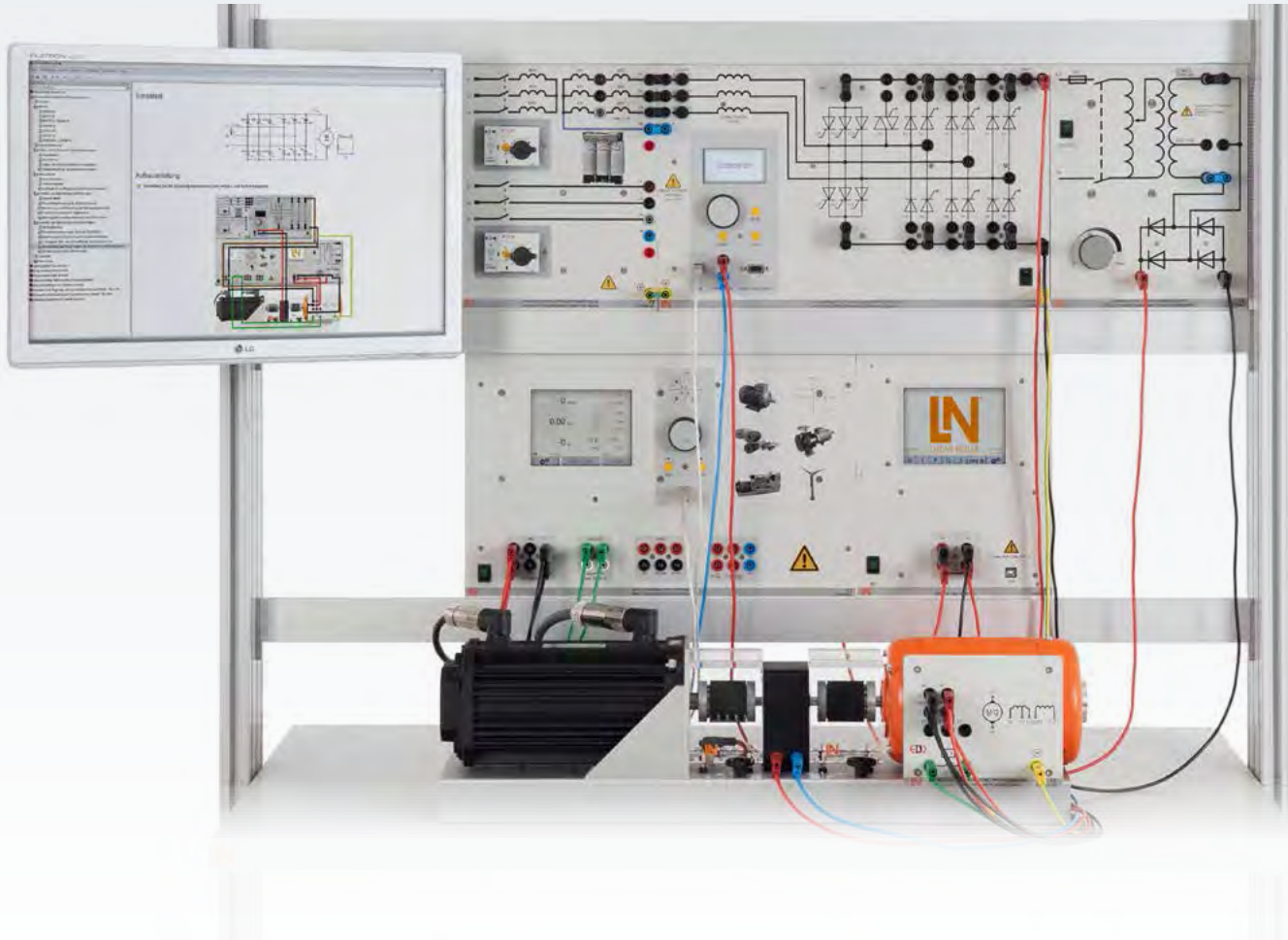

Variable-speed DC drives excel thanks to their very good speed and torque controllability and extremely high dynamic response. When it comes to power semiconductors operating with large-scale drives at high power levels, one resorts to line-commutated converters with thyristors. These components stand out because of their capacity to handle overload and their low tendency for power losses.

Training contents

- Closed-loop speed control in the 1st and 4th quadrant with and without cascade current control
- Energy recovery
- Closed-loop speed control, current control, cascade control, adaptive control
- Computer-assisted controlled system and controller analysis parametrization
- P, PI, PID speed control
- Control loop optimization

Order no. EPE 31

SELF-COMMUTATED CONVERTER CIRCUITS



300 W and 1 kW classes available

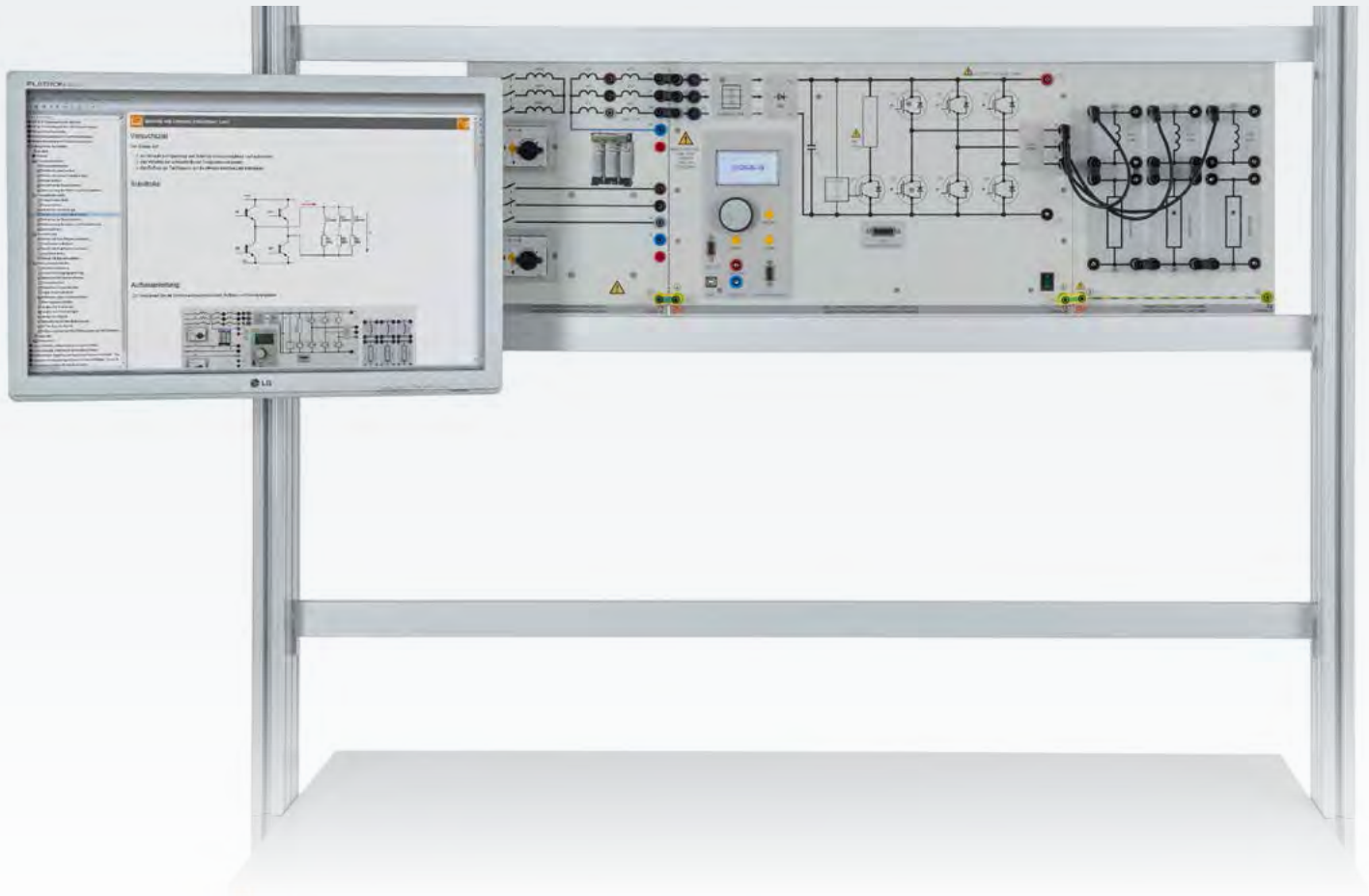

The widespread proliferation of power electronics equipment requires that electronics specialists and engineers alike have a profound command of knowledge enabling them as users to handle the equipment competently and in a resource-saving manner or put them in a position to explore this material in greater detail in research and development. For that reason, power converters are an essential constituent of the curricula of students of electronics and electrical engineering. The „self-commutated converter circuit“ training system uses sophisticated experiments with hands-on and project-based work to explore the fundamentals. Circuitry, modulation and rotary field generation are core subjects rendered easily comprehensible thanks to supplementary theory and special animations for rapid learning progress to the next level of expertise.

Training contents

- Pulse-width modulation
- DC chopper in single quadrant and 4-quadrant operation
- AC controller
- Three-phase power converter with block / sine commutation and space vector modulation
- Resistive and inductive load
- Suppressor circuitry, link circuit, free-wheeling
- Control characteristics and operating diagrams
- Interpolation, clock frequency, ripple
- Frequency analysis and examination of harmonics

Order no. EPE 40

FREQUENCY CONVERTERS



300 W and 1 kW classes available

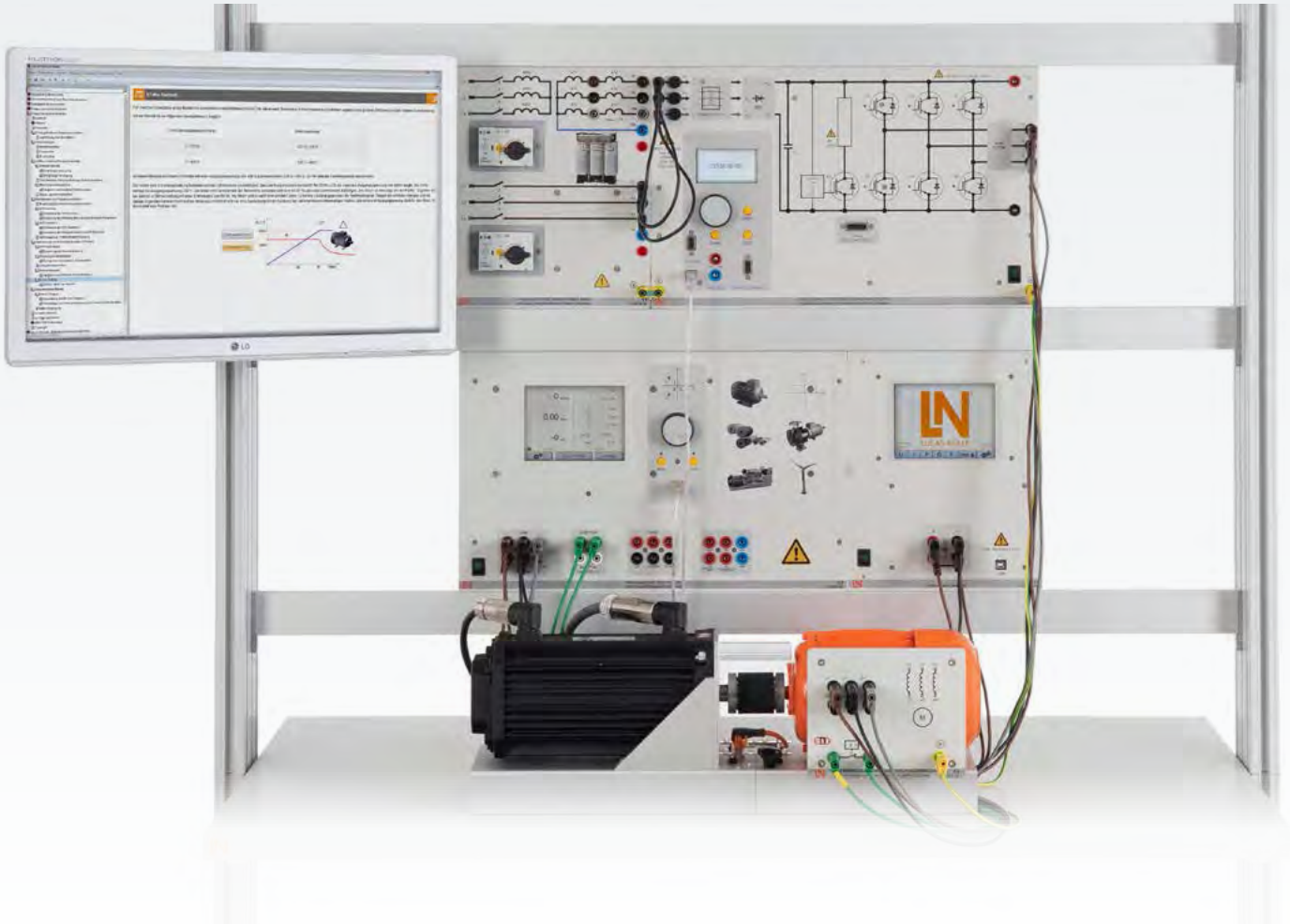

Modern frequency converters transform any standard three-phase motor into a speed-variable drive. The ruggedness and vast proliferation of the standard three-phase motor have played a big role in the huge success enjoyed by electronic drive technology using frequency converters. Today, frequency converters can be found in a host of applications like in textile machinery, packaging machinery, hoisting equipment and even in washing machines. The interplay between power electronics and motors can be explored and studied using the „Frequency converter drives“ training system.

Training contents

- Distinction between various converter types
- Design of modern frequency converters
- Link circuit
- Brake chopper
- Control methods (U/f characteristic, U/f² characteristic, vector control)
- Speed adjustment, speed ramps
- Optimization procedures
- Analysis of voltage and frequency ratios

SERVO DRIVES, ELECTRONICALLY COMMUTATED MOTOR



300 W and 1 kW classes available

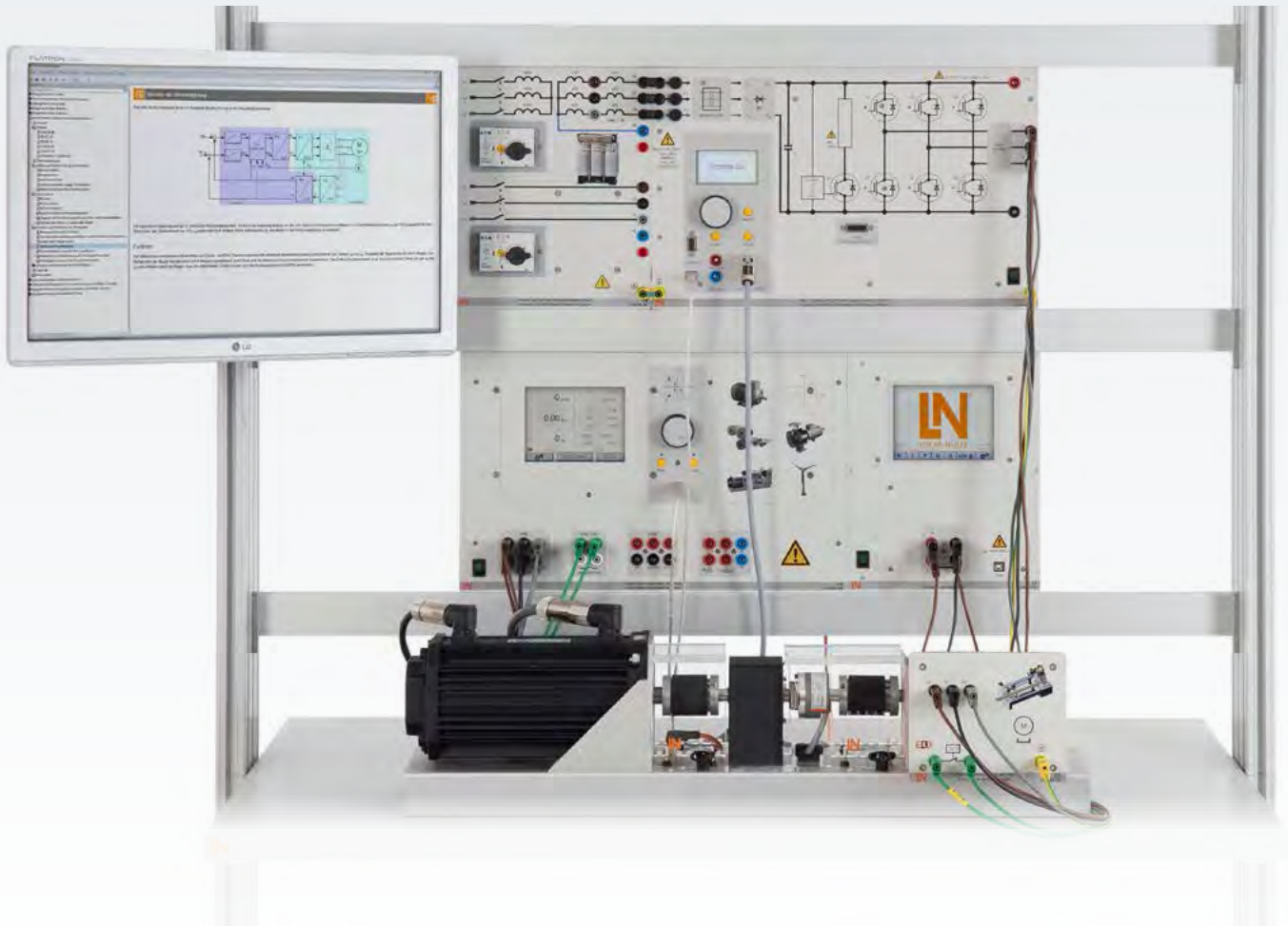

Servo drives are variable-speed drives designed to meet high dynamic response and overload demands. They are frequently deployed in automation solutions subject to radical speed and torque variations, such as tooling machines or robotic systems. The „Servo drives“ training system clearly demonstrates the functionality of a variable-speed servo system with permanent magnet.

Training contents

- Design of the servo drive
- Investigating the coordinate and encoder systems
- Operating principle of servo motors with electronic commutation
- Modulation analysis
- Control structure design
- Analysis of speed-variable drives

INVERTER-FED DRIVES WITH DC MOTORS



300 W and 1 kW classes available



Thanks to their simple control structure, inverter-fed drives with DC motors are ideally suited to serve as an introduction to the subject of speed-variable drives. By considering closed-loop current control and speed control separately, students are able to put the controller into operation and optimize it step-by-step. The training system graphically demonstrates how a speed-variable system operates.

Training contents

- Open-loop speed control in single quadrant operating mode
- Open-loop speed control in four quadrant operating mode
- Closed-loop speed control
- Closed-loop current control
- Automatic cascade control
- Computer-assisted analysis of controlled systems and controllers
- P, PI controller parametrization
- Controller optimization

A photograph of two male engineers in a laboratory setting. They are working on a silver motor mounted on a metal frame. The engineer in the foreground is using a multimeter to test the motor's wiring. The background shows a white cabinet with 'VL DYNOLUTION' and '+CS' labels, and another person in a black jacket with an Audi logo. The scene is brightly lit, and various cables and hoses are visible.

MODEL-BASED DEVELOPMENT OF DRIVES USING MATLAB[®]/SIMULINK[®]



Almost all electrical drives found in industrial plants and electrically powered vehicles operate with three-phase technology. By operating these drives with automatic control systems, they can attain smooth starting or precision accelerations. This is predicated on comprehensive programming involving sophisticated mathematics. Implementation is often characterized by relatively long development times.

By using Matlab®/Simulink® and Lucas-Nülle systems, you can integrate into your classroom the simulation of complex controller structures for three-phase drives. The trick: the students can then test simulated structures on a real converter with motor and load using automatically generated code.

PROGRAMMABLE RAPID PROTOTYPING SYSTEM FOR DRIVE TECHNOLOGY



Benefits

- Secure handling thanks to intrinsically safe hardware (all safety functions are implemented independently of the software)
- Promotes in-depth understanding of complex subjects covered in education and training or by using the toolbox in laboratory programs supporting theoretical material
- Very fast, model-based, parametrizable software generated for own controllers used in conjunction with industrial applications
- Pursue new methods to explore rotary field drives, e.g. using state-space methods, conditions monitoring for faults, sensor-less automatic speed control using new monitoring techniques
- Impressive potential for designing automatic control systems for three-phase drives
- Create sophisticated algorithms with faster control cycles of 125 μ s
- Parametrization of P-action, PI-action controllers
- Controller optimization

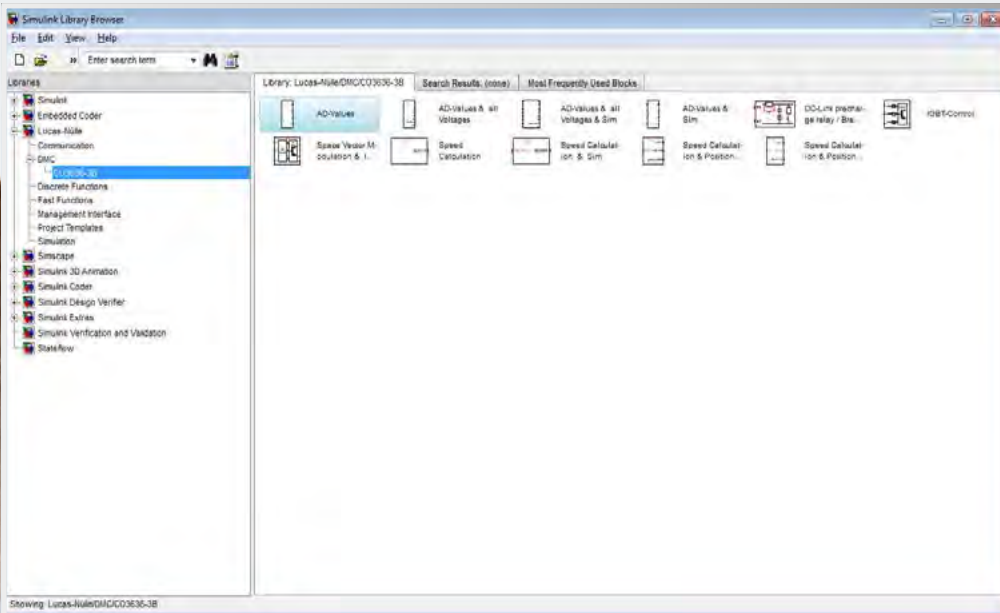

Faster results with the Matlab®-Toolbox

A toolbox designed to match the power electronics hardware permits the rapid implementation of customized applications. Special templates permit easy introduction by configuring the system so that the user only has to make a few slight adjustments. The toolbox provides users with all the necessary modules for automatic control of hardware-related functions and includes blocks for fast transformations and controllers. The system can be extended as desired simply by adding elements from Matlab®/ Simulink®

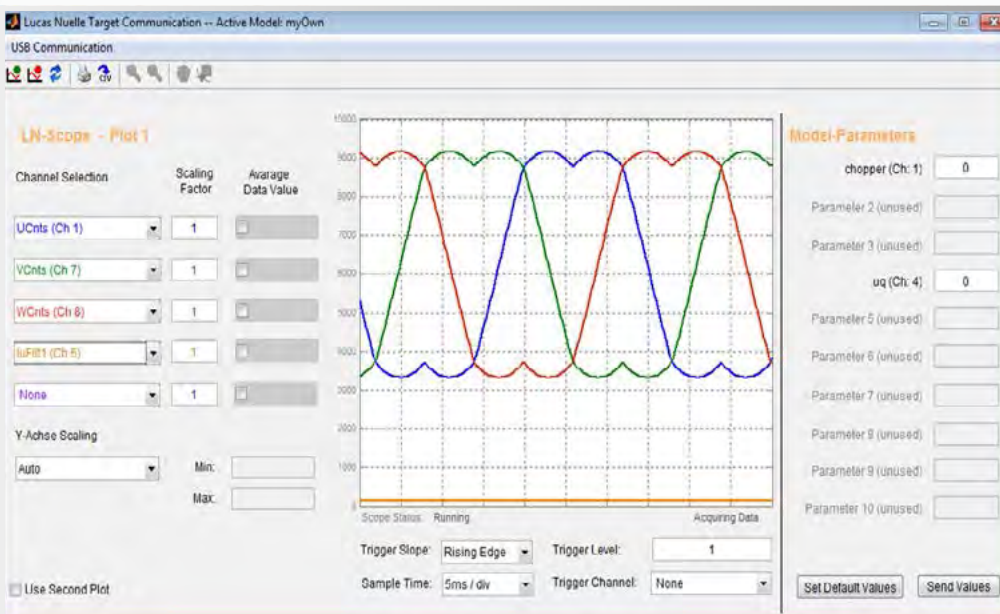

Hardware connection using Matlab® Scope

A special graphic dialogue serves to establish the connection between Matlab® and the hardware via a USB interface. The time characteristics of all internal variables can be visualized during runtime. A series of different time resolutions and trigger options are available here. The signals can be displayed in the time and frequency domain. The display can be divided into two units so that up to ten different signals can be visualized at the same time. Parameters, for example for the controller, can be uploaded conveniently from the PC to the hardware during runtime.

FIELD-ORIENTED CONTROL OF ASYNCHRONOUS (INDUCTION) MOTORS WITH MATLAB® / SIMULINK®



300 W and 1 kW classes available

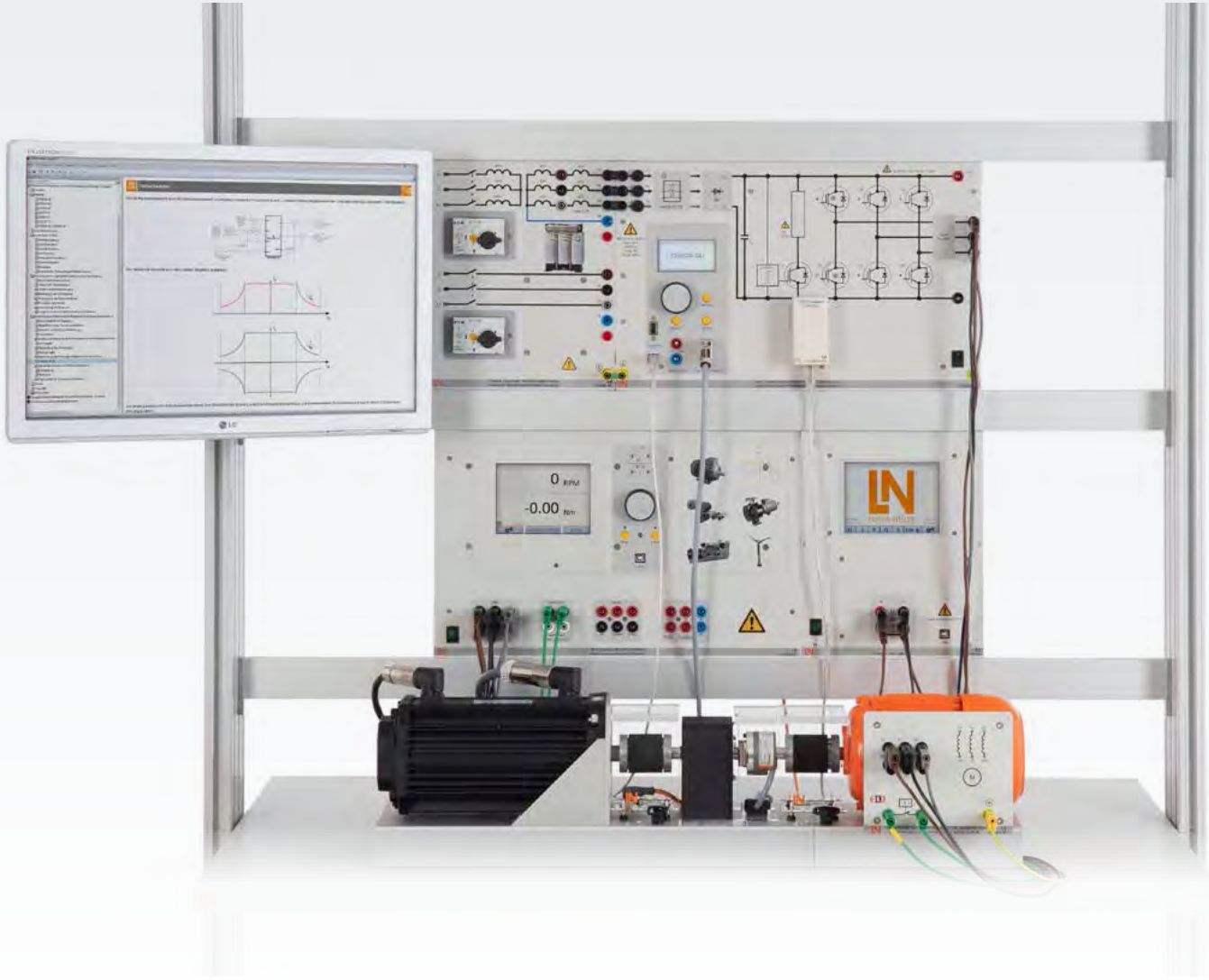

Three-phase drives are used today in almost all electrical drives. Mathematically the automatic control of such drives is both a complex and costly undertaking. The training system makes it possible to simulate sophisticated control algorithms with the aid of the special toolbox for Matlab®/ Simulink® and subsequently test them by means of automatically generated code on real intrinsically safe hardware incorporating a motor and load.

Training objectives

- Creation of a HIL system (hardware in the loop) under real-time conditions
- Model conception and design for field-oriented control on a continuous design level
- Breaking the control system down into discrete units for operation on a DSP (digital signal processor)
- Creation and optimization of current and speed controllers
- Park and Clarke transformation
- Integration of space vector modulation for the optimum control of IGBTs
- Decoupling of field-oriented currents and voltages
- Speed-detection using an incremental encoder
- Comparison of simulation results with real measurements

Order no. EPE 51

INTERACTIVE LEARNING PLATFORM

Ersatzschaltbild Drehstromasynchronmotor

Drehstrom-Narsschlusssynchronmotoren besitzen aus drei Stator- und drei Rotorspulen (magnetisch sind die Rotorspulen als Spulen zu sehen).



Reduziert man die Betrachtung auf eines der drei gekoppelten Spulenpaare, vereinfacht sich das Bild erheblich. Da es sich um ein symmetrisches System handelt, gelten alle Überlegungen auch für die anderen beiden Spulenpaare.



Einzeltes einphasiges Ersatzschaltbild

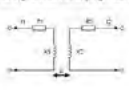

Gekoppeltes Spulenpaar einer Wicklung

Aufgrund des Kupferdrahtes besitzen die Spulen neben der Induktivität L auch einen parasitären, ohmschen Widerstand R . Der Strom durch die Spulen wird sowohl vom ohmschen als auch vom induktiven Anteil bestimmt. Da die Spulen in ein Wechselstromsystem angeschlossen werden, besitzen die Induktivitäten einen Wechselstromwert (Reaktanz), der ω Ohm gemessen wird:

$$X_L = \omega L + j\omega M$$

Die Spulen verhalten sich gegenseitig mit einer magnetischen Induktion M . Die Statorspule erzeugt einen Strom in der Rotorspule und umgekehrt. Man kann daher das eine einphasige Ersatzschaltbild in ein verteiltes überführen. In diesem Ersatzschaltbild wird der Kupferwiderstand von einem Strom I durchflossen, aber für die Magnetisierung von Stator und Rotor sorgt:

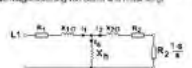

In dieser Darstellung wird die mechanische Belastung des Rotors durch den Lastcharakter auf der rechten Seite berücksichtigt und der Schaltkreis verwendet, um die Größe der Belastung darzustellen.

Grenzbetrachtungen:

- **Leertlauf**
Der Ausblick (ω) ist gleich dem Leerlauf ($\omega = 0$) gegen einstellbar und es fließt kein Strom I_1 .
- **Die gesamte von der Maschine aufgenommene Strom I_1 ist identisch mit dem Magnetisierungsstrom I_m .**
- **Mechanische Belastung**
Unter mechanischer Belastung fällt bei der Asynchronmaschine die Drehzahl und entsprechend sinkt der Schlupf. Es verbleibt ein von der mechanischen Belastung abhängiger Strom I_1 , der von der Maschine subventionierte Strom I_1 , fest auf ein einen Magnetisierungsstrom I_m und einen lastabhängigen Wirkstrom I_1 .

How does field-oriented control work?

Nowadays drives with field-oriented control can be found in many machines. These drive systems stand out for their high dynamics as well as ample torque reserves. The ILA course guides the student step-by-step through the topics of field-oriented control. Besides the creation of a process-control model, the course also covers the topics of control optimization and testing.

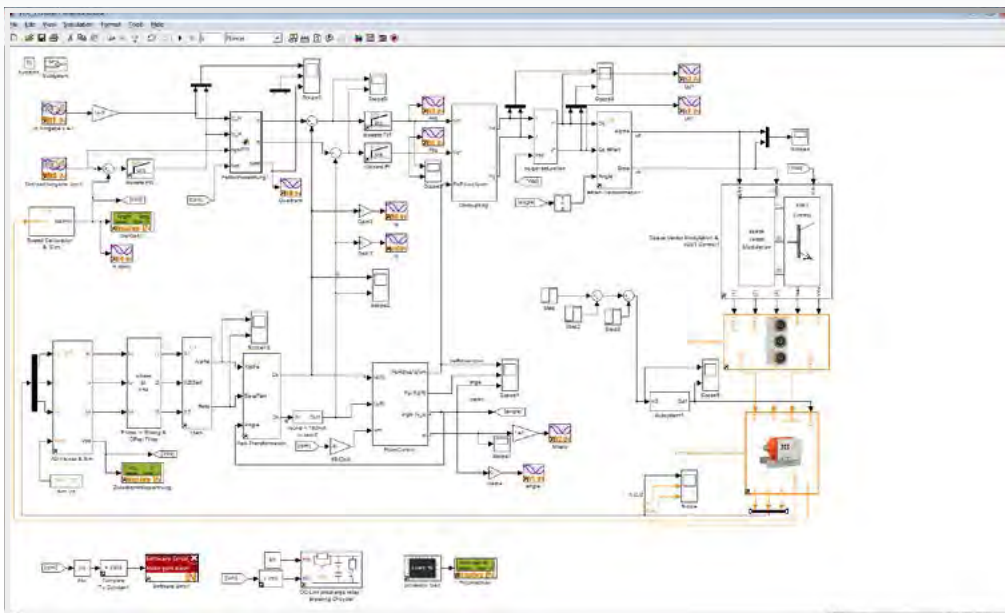

Simulation or real control? - you decide.

A single Simulink® model forms the foundation for the simulation or the program for the real hardware. It is only after completion that the user can decide between the simulation and the real system. Accordingly, it is possible to test and optimize the control loop during simulation and then use the model to put it into operation with the hardware. This procedure guarantees rapid learning progress. At the same time, the differences between a simulation and a real system is understood and appreciated.

VARIABLE-SPEED PERMANENT MAGNET SERVO DRIVES WITH MATLAB® / SIMULINK®



300 W and 1 kW classes available

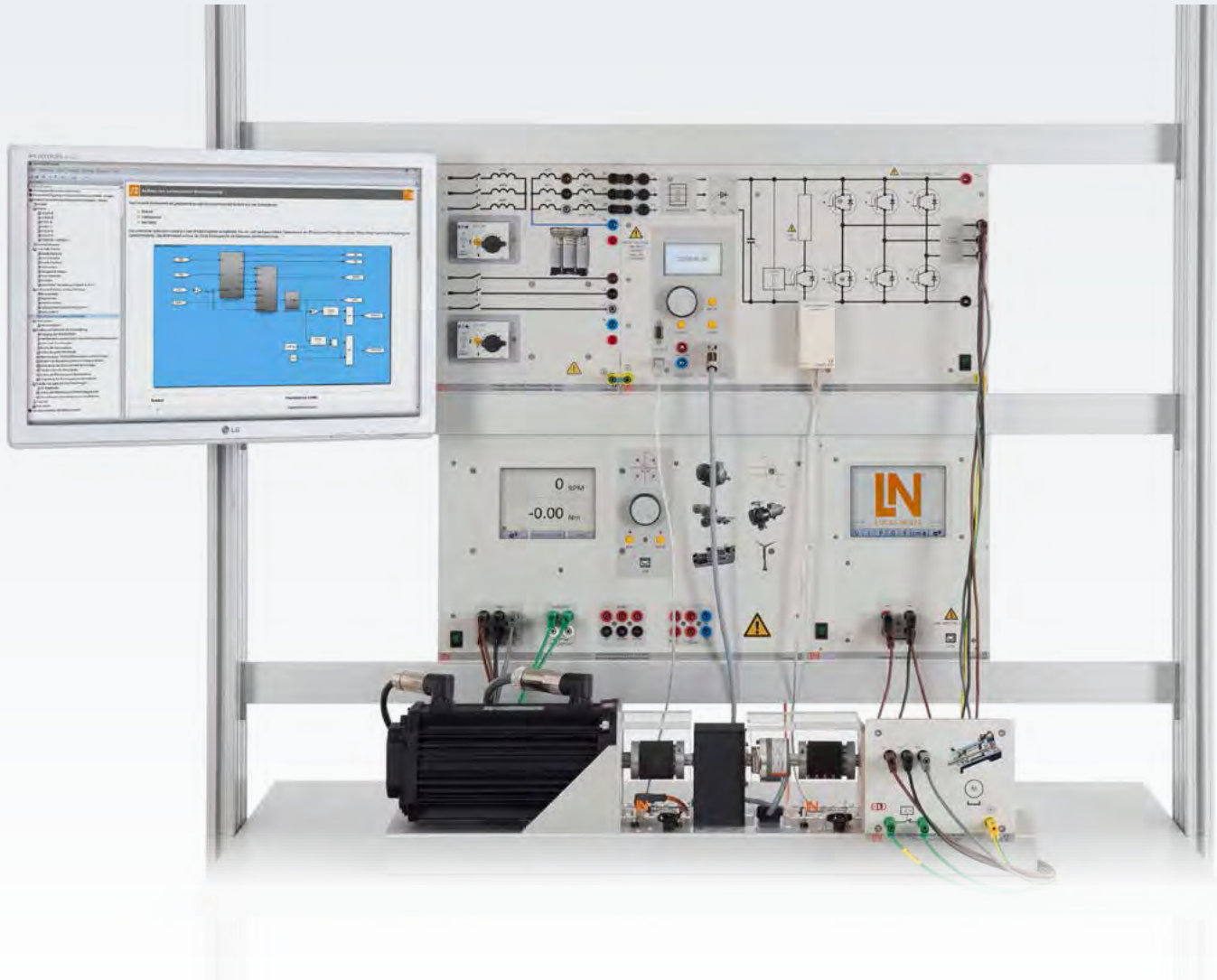

Synchronous servo motors are deployed in many modern drives. Not only the high dynamics but also energy efficiency play a huge role here. With the training system, existing control concepts can be examined in detail and new approaches can be tried out safely thanks to the open programming using Matlab®/Simulink®. This makes it possible to create typical industrial drives or drives from the automotive sector.

Training objectives

- Creating a hardware-in-the-loop system under real-time conditions
- Modelling and design of the automatic servo control on a continuous design level
- Breakdown of automatic control into discrete elements for operation on a DSP
- Creation and optimization of current and speed controller
- Park and Clarke transformation
- Integration of space-vector modulation for optimum control of IGBTs
- Decoupling of field-oriented currents and voltages
- Speed and position detection using an incremental encoder
- Comparison of simulation results with real measurements

Order no. EPE 52

INTERACTIVE LEARNING PLATFORM

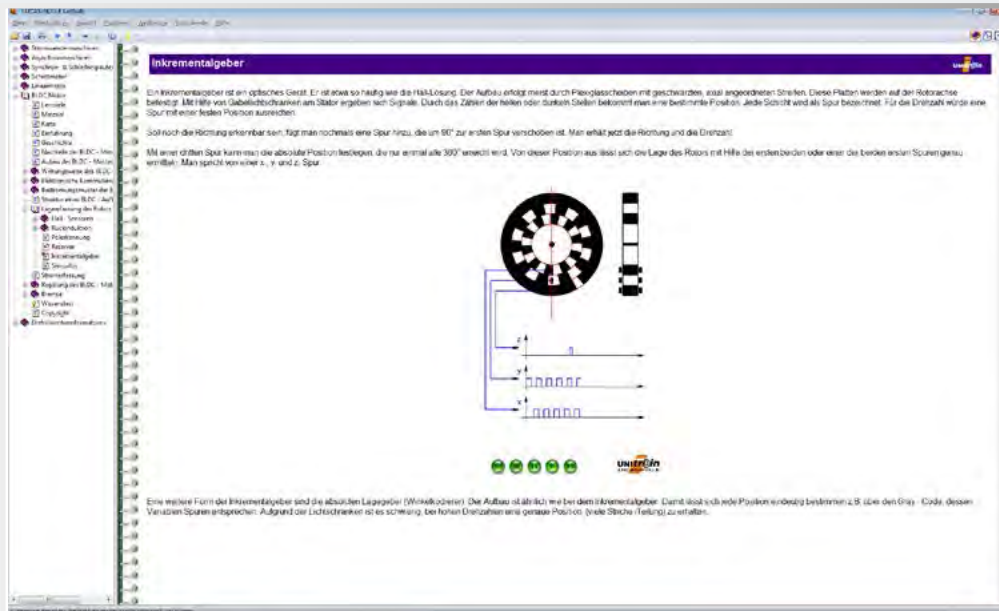

How does a drive with synchronous servo motor respond?

Permanently excited synchronous motors do not operate without the appropriate control electronics. Design a synchronous servo drive. Commencing with open-loop controlled operation, work through the subject up to and including closed-loop control operation. The ILA course guides you step-by-step through the material. The open system allows you to use your imagination to easily implement your own creative ideas to expand the drive.

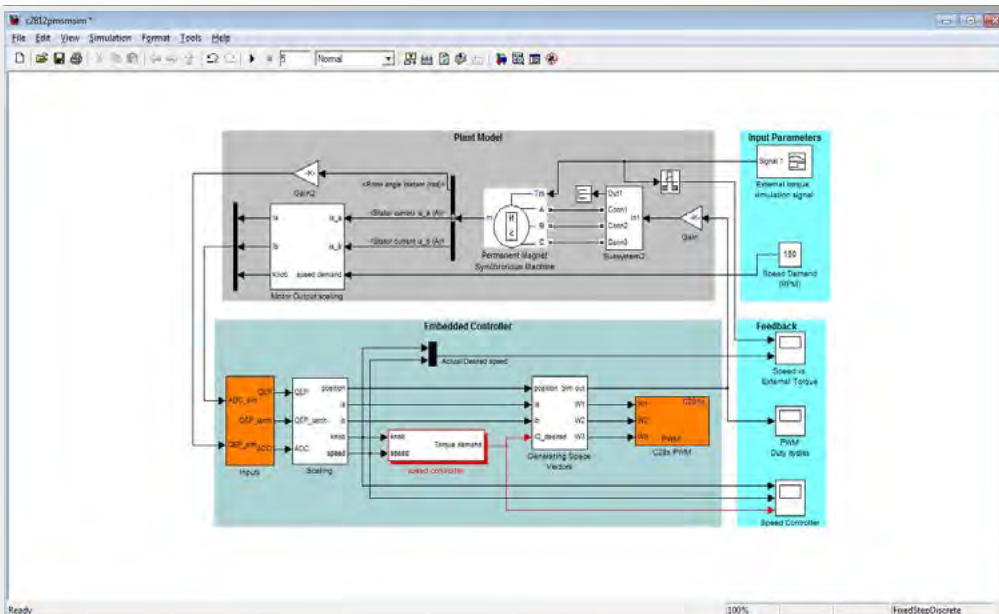

How is the dynamic response of my drive?

Use the servo machine test system to examine the drive. A variety of load emulations are available. For example, a flywheel can be used to investigate the control response of the drive under real operating conditions. Optimize the settings of the controller parameters and decide for yourself how well your drive performs.

DC DRIVES WITH CASCADE CONTROL USING MATLAB® / SIMULINK®



300 W and 1 kW classes available



Thanks to their clearly arranged control structure, converters with DC motors are particularly well suited for programming your very own initial control algorithms. The training system permits implementation, optimization and operation of your own control configurations. In addition to classic approaches, this open system enables you to also safely explore new ideas and novel expansions.

Training objectives

- Creating a hardware-in-the-loop system under real-time conditions
- Modelling and design of cascade control for DC motor on a continuous development level
- Breakdown of automatic control into discrete elements for operation on a DSP
- Creation and optimization of current and speed controllers
- Speed detection via an incremental encoder
- Comparison of simulation results with real measurements

INTERACTIVE LEARNING PLATFORM

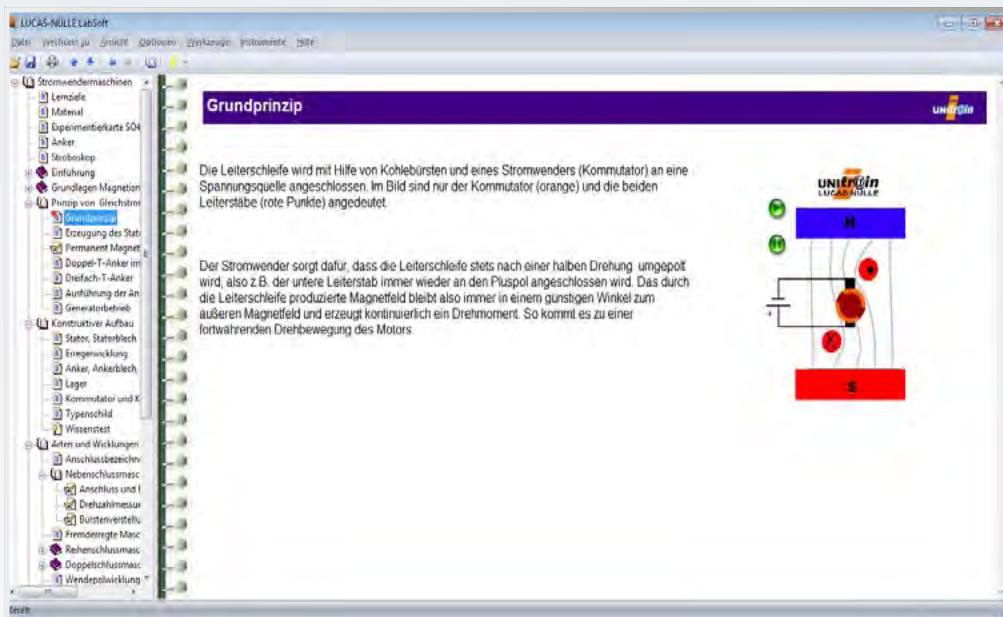

How does a DC drive with variable-speed work?

The ILA course demonstrates the design, configuration and commissioning of a DC drive based on a hands-on example. The current and speed controller is implemented and optimized step-by-step. Success in the form of long-lasting learning is guaranteed through direct application of a control engineering model and work on a real system.

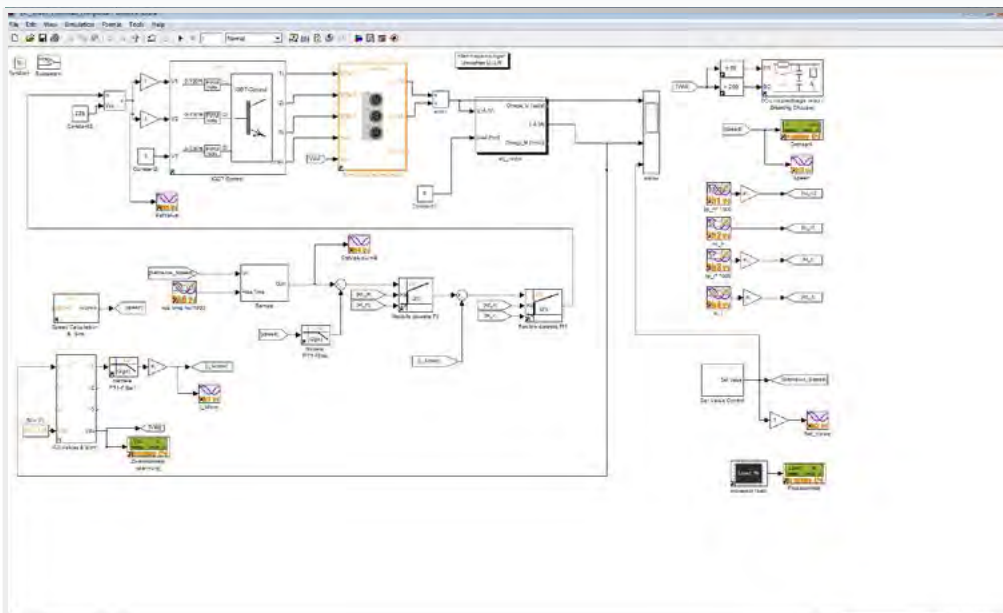

How are controllers designed?

With this training system you can design and test the controller as a simulation and in a real system. Using the graphic interface, you have optimum access to the dynamic signals of the controlled variables. That way it is possible to undertake quick changes to the settings and to test these settings.

A close-up photograph of industrial machinery. The top half shows a large, circular metal component with a central hub and a scalloped orange-painted outer edge. Below this, a row of smaller, grey cylindrical components is visible, each topped with a different colored cap (green, red, white, red, orange, white). The background is a blurred industrial setting.

INDUSTRIAL DRIVE TECHNOLOGY



PRINT

Automatically controlled electrical drives are omnipresent. They are used as special drives with high power. They are also built into traction drives and integrated into tooling and production machinery and are even used in the motor vehicle industry. Expertise in the area of electrical drives is essential in many occupations. For that reason, practical hands-on training is all the more important.

In contrast to classic drives used in education, the Lucas-Nülle training systems are outfitted with real industrial equipment made by well-known manufacturers like Lenze or Siemens. This approach makes it possible to convey theoretical knowledge directly into industrial applications. The designations of all the connections and terminals correspond to industrial practice. The exercises and projects include authentic industrial operating instructions. This is how users quickly become familiar with the configurations and settings of smooth starters, frequency converter drives, servo drives and motor management relays.

SMOOTH STARTING WITH THREE-PHASE MACHINES



300 W and 1 kW classes available



Smooth starters use phase-angle control to reduce the motor voltage during switch-on. The starting current drops proportionally to the terminal voltage. The power component of a smooth starter is usually comprised of two thyristors per phase switched antiparallel. To keep the power losses and the contingent heat arising from this as low as possible, the power semiconductors are shunted by an integrated power circuit-breaker subsequent to the start-up phase.

Training contents

- Putting into operation
- Setting the parameters for run-up and run-down and starting voltage
- Examination of current and voltage during starting
- Starting under different load scenarios
- Comparison to star-delta starting

DRIVES WITH FREQUENCY CONVERTERS



300 W and 1 kW classes available

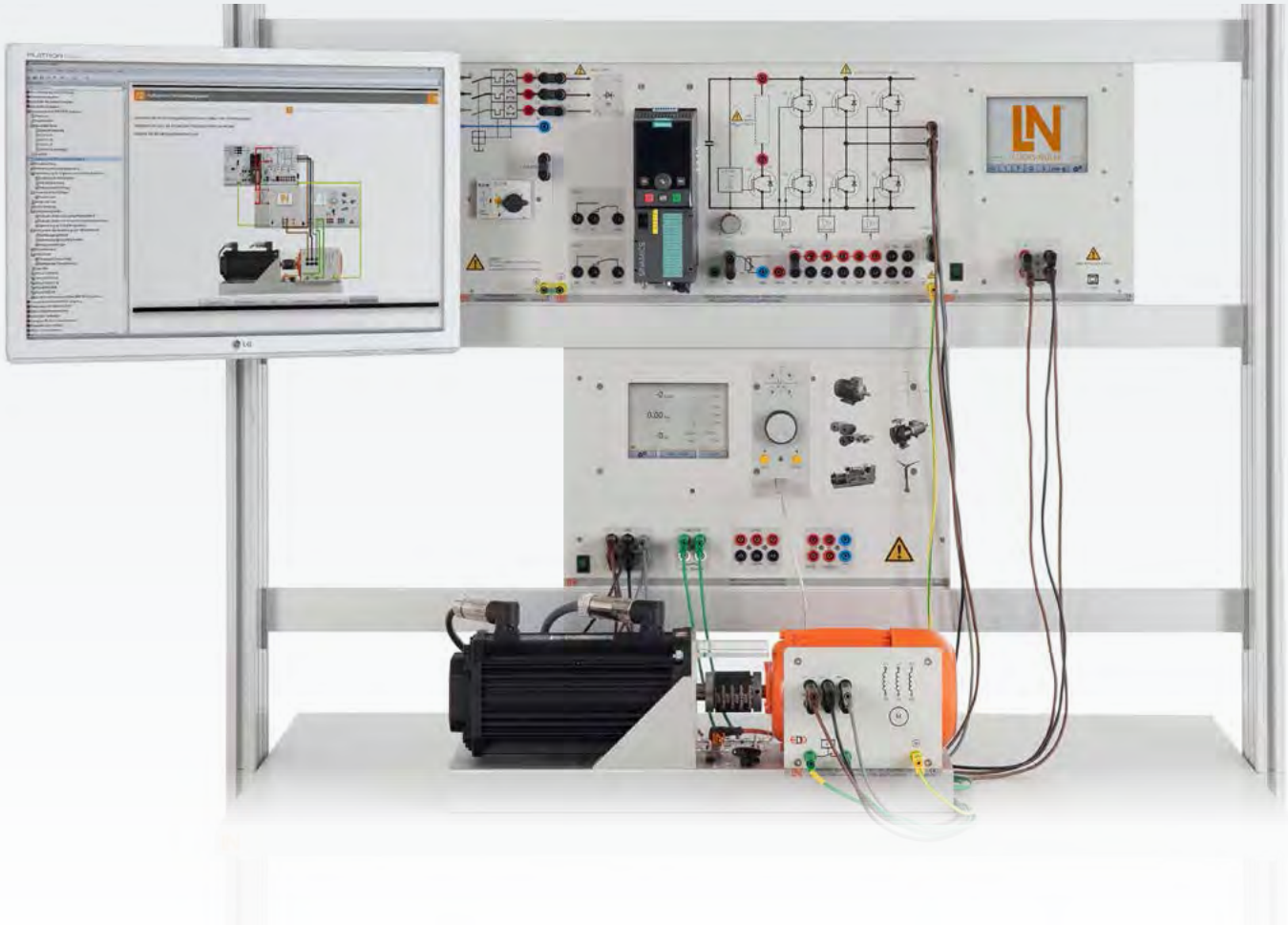

Modern frequency converters transform any given three-phase standard motor into a speed-variable drive. The robust nature and broad popularity of the three-phase standard motor have played a major role in the success enjoyed by electronic drive technology with frequency converters. The higher demands placed on drives due to rapid advances in process automation means that more and more motors are controlled by frequency converters. Thanks to needs-based open-loop speed control, today it is possible to save substantial amounts of energy in pumps and air-conditioning systems.

Training contents

- Computer-assisted set-up and operation
- Parametrization of setpoint variables, rotation direction, starting operation, operating frequency
- limiting values, nominal voltage, nominal current, nominal frequency, power factor etc.
- Investigating operating response under working machine loads
- Recording the speed-torque characteristics across all four quadrants
- Drive optimization
- Operation with brake chopper
- Operation with vector control

Order no. EDT 25

PROJECT WORK INVOLVING FREQUENCY CONVERTERS



Frequency converters – design – industrial-type wiring –
The training system „Frequency converter project work“
is designed to provide students with hands-on training on
how to set up and wire industrial components in a control
cabinet. The use of frequency converters and mini-con-
trols is an ideal way to combine drive and process control
technology. This is how various industrial-type projects
can be set up, configured and tested. The use of the servo
machine test system makes it possible to test the project
work under realistic conditions.

Training contents

- Drafting, implementing and analyzing circuit diagrams
- EMC compliant design and wiring of the control cabinet using industrial components
- Putting the system into operation
- Approval and acceptance according to DIN EN standards
- Protective conductor measurement
- Insulation measurement
- Parametrization of the frequency converter
- Programming the LOGO!® compact control

POSITIONING WITH A LINEAR AXIS



The focus of this training system is on practical hands-on learning of how modern positioning drives function and operate. The servo-machine testing system is operated as a positioning drive on a linear axis. Using software designed for education, students can explore hands-on how the positioning drive operates in the context of project work.

Training contents

- Computer-assisted set-up and configuration of a positioning drive with linear axis
- Setting the parameters via software specially designed for education purposes
- Investigation of the effects of different parameters on the positioning process
- Positioning optimization
- Homing function (reference calibration)

POSITIONING WITH SYNCHRONOUS SERVO DRIVES

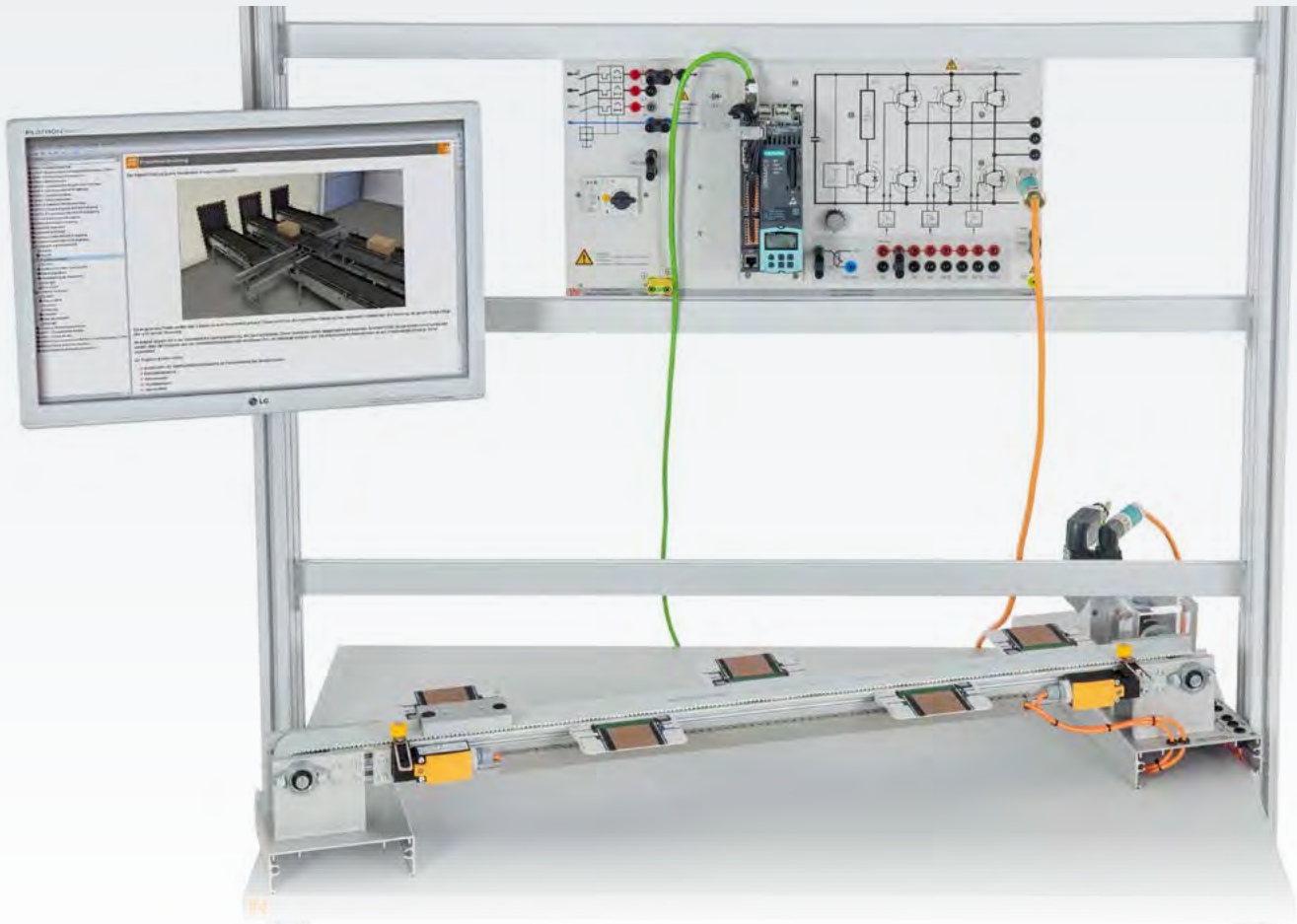

When people talk about servo drives today they generally mean highly dynamic three-phase drives. Servo drives primarily perform positioning duties in tooling machinery, manipulators or robots. But they are also being found more and more in printing machinery, conveyor belt systems and cutting machinery, where precision positioning or angular synchronism is required. In these cases, the servo converter, motor with sensor technology and the mechanical transfer elements form a tightly integrated system, whose components have to be seen as a single entity.

Training contents

- Computer-assisted set-up and configuration of a servo drive with linear axis
- Positioning and sequential process control
- Parametrization of the position and speed controller using a simple industrial parameter setting software
- Homing function (referencing)
- Investigating the effects of various controller settings operated with different loads

MOTOR PROTECTION / MOTOR MANAGEMENT



300 W and 1 kW classes available

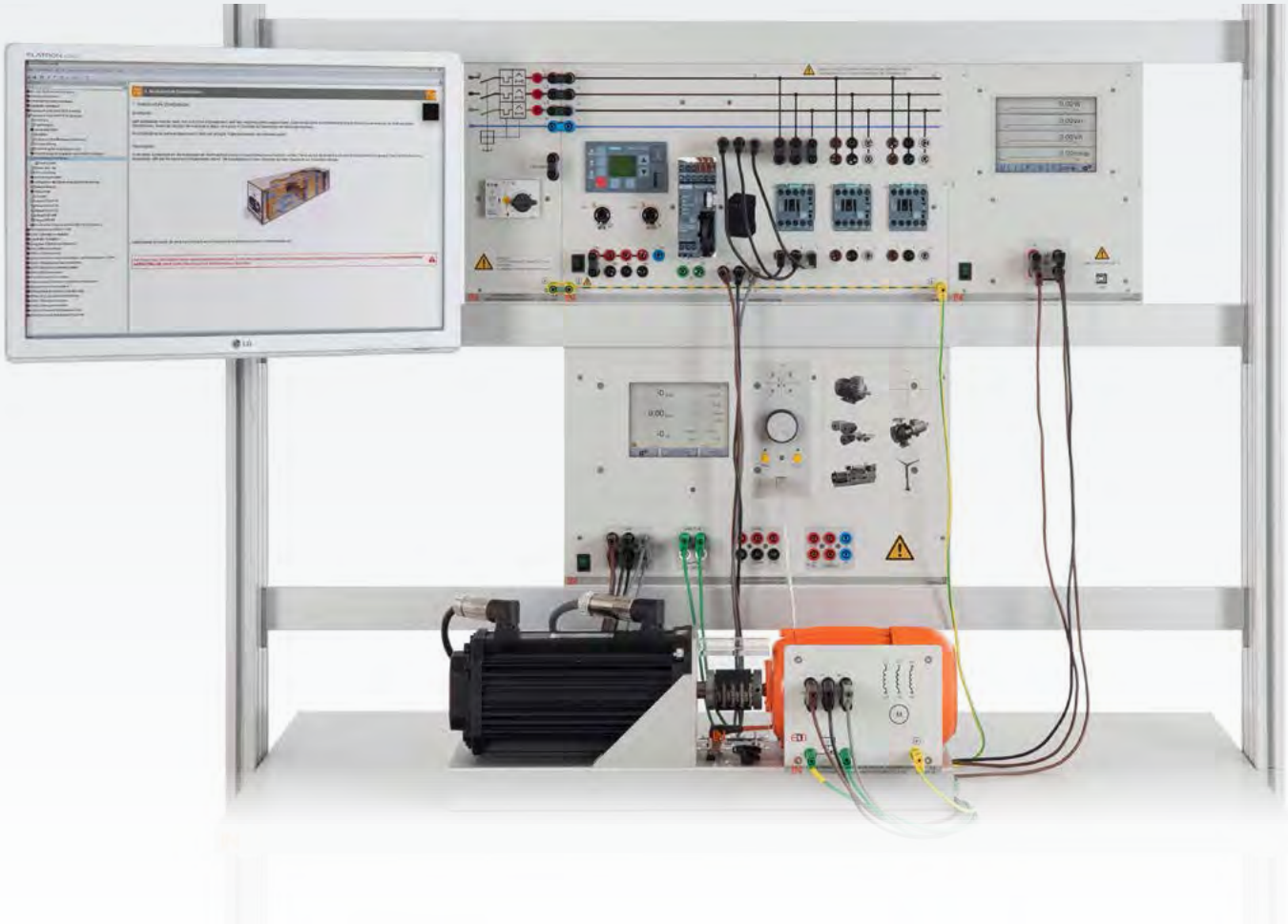

Motor management systems are deployed in automation systems and provide optimum protection, control and monitoring potential for drives and systems. These systems permit, for example, detection of motor temperature, voltage and current. The transparency of motor operation is improved thanks to the connection to the primary process automation via the field bus systems (e.g. PROFIBUS). This makes it possible to remotely determine system capacity and energy consumption without having to take measurements on location.

Training contents

- Computer-assisted set-up and operation
- Programming such functions as direct start-up, star-delta starting, starting of pole-switchable motors, motor protection
- Setting the parameters for overload variables and shut-off response for different loads
- Measurement of dynamic processes during starting
- Precautionary maintenance

Order no. EDT 51



Representative

Technology Education Concepts
www.TECedu.com | 800-338-2238
info@TECedu.com



LUCAS-NÜLLE GMBH

Siemensstr. 2
50170 Kerpen, Germany

Tel.: +49 2273 567-0
Fax: +49 2273 567-69

www.lucas-nuelle.com
export@lucas-nuelle.com

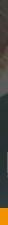

Training systems for driver technology